

Datacom Analyzer

Operating and Calibration Manual

SERIAL NUMBERS

This manual applies directly to datacom modules connected to host instruments with serial numbers prefixed 3202U and/or with firmware revision (MAIN) number 3310.

To check the firmware revision number of your host instrument, press **OTHER** and select **FIRMWARE & OPTIONS**.



HP Part No. 15901-90014

Microfiche Part No. 15901-90039

Printed in U.K. March 1993

WARNING

READ THE FOLLOWING NOTES BEFORE INSTALLING OR SERVICING ANY INSTRUMENT.

1. IF THIS INSTRUMENT IS TO BE ENERGISED VIA AN AUTO-TRANSFORMER MAKE SURE THAT THE COMMON TERMINAL OF THE AUTO-TRANSFORMER IS CONNECTED TO THE NEUTRAL POLE OF THE POWER SOURCE.
2. THE INSTRUMENT MUST ONLY BE USED WITH THE MAINS CABLE PROVIDED. IF THIS IS NOT SUITABLE, CONTACT YOUR NEAREST HP SERVICE OFFICE. THE MAINS PLUG SHALL ONLY BE INSERTED IN A SOCKET OUTLET PROVIDED WITH A PROTECTIVE EARTH CONTACT. THE PROTECTIVE ACTION MUST NOT BE NEGATED BY THE USE OF AN EXTENSION CORD (POWER CABLE) WITHOUT A PROTECTIVE CONDUCTOR (GROUNDING).
3. BEFORE SWITCHING ON THIS INSTRUMENT:
 - a. Make sure the instrument input voltage selector is set to the voltage of the power source.
 - b. Ensure that all devices connected to this instrument are connected to the protective (earth) ground.
 - c. Ensure that the line power (mains) plug is connected to a three-conductor line power outlet that has a protective (earth) ground. (Grounding one conductor of a two-conductor outlet is not sufficient).
 - d. Check correct type and rating of the instrument fuse(s).

WARRANTY

This Hewlett-Packard product is warranted against defects in materials and workmanship for a period of one year from date of shipment. During the warranty period, Hewlett-Packard Company will, at its option, either repair or replace products which prove to be defective.

For warranty service or repair, this product must be returned to a service facility designated by HP. Buyer shall prepay shipping charges to HP and HP shall pay shipping charges to return the product to Buyer. However, Buyer shall pay all shipping charges, duties, and taxes for products returned to HP from another country.

HP warrants that its software and firmware designated by HP for use with an instrument will execute its programming instructions when properly installed on that instrument. HP does not warrant that the operation of the instrument, or software, or firmware will be uninterrupted or error free.

LIMITATION OF WARRANTY

The foregoing warranty shall not apply to defects resulting from improper or inadequate maintenance by Buyer, Buyer-supplied software or interfacing, unauthorized modification or misuse, operation outside of the environment specifications for the products, or improper site preparation or maintenance.

~~NO OTHER WARRANTY IS EXPRESSED OR IMPLIED. HP SPECIFICALLY DISCLAIMS THE IMPLIED WARRANTIES OF MERCHANTABILITY AND FITNESS FOR A PARTICULAR PURPOSE.~~

EXCLUSIVE REMEDIES

THE REMEDIES PROVIDED HEREIN ARE BUYER'S SOLE AND EXCLUSIVE REMEDIES. HP SHALL NOT BE LIABLE FOR ANY DIRECT, INDIRECT, SPECIAL INCIDENTAL, OR CONSEQUENTIAL DAMAGES, WHETHER BASED ON CONTRACT, TORT, OR ANY OTHER LEGAL THEORY.

CERTIFICATION

Hewlett-Packard Company certifies that this product met its published specifications at the time of shipment from the factory. Hewlett-Packard further certifies that its calibration measurements are traceable to the United States National Bureau of Standards, to the extent allowed by the Bureau's calibration facility and to the calibration facilities or other International Standards Organization members.

ASSISTANCE

Product maintenance agreements and other customer assistance agreements are available for Hewlett-Packard products.

For any assistance, contact your Hewlett-Packard Sales and Service Office. Addresses are provided at the back of this manual.

NOTICE

The information contained in this document is subject to change without notice.

Hewlett-Packard shall not be liable for errors contained herein or for incidental or consequential damages in connection with the furnishing, performance or use of this material.

This document contains proprietary information which is protected by copyright. All rights are reserved. No part of this document may be photocopied or reproduced without the prior written consent of the manufacturer, Hewlett-Packard Ltd.

EMC COMPLIANCE

This product has been tested and complies with FTZ 1046 when used with the following cables:

Cable	HP Part Number
RS-232 (on left side-panel)	HP 15714A E01
3-pin Siemens	HP 15512A E01
RS-232/V.24	HP 15714A E01
V.35	HP 15708A E01
RS-449/V.11	HP 15692A E01

PRINTING HISTORY

Edition 1 (15901-90002) April 1991
Edition 1 (15901-90009) January 1993
Edition 1 (15901-90014) March 1993

Contents

1. Getting Started	
Introduction	1-1
Switch-On	1-2
To Select the Datacom Default Settings	1-4
To Choose EFS or %EFS as the Current Results Display	1-6
Making a Measurement on Asynchronous Data	1-7
Procedure	1-7
Making a Measurement on Synchronous Data	1-12
Procedure	1-12
Measuring RTS/CTS Delay	1-17
Procedure	1-17
2. Making BER Measurements	
To Configure the Instrument as a Datacom Analyzer	2-2
To Recall Stored Settings	2-3
To Select the Datacom Interface	2-4
V.24 Interface with Breakout Facility	2-4
V.11 and V.35 Interface	2-6
X.21 Leased Interface	2-6
To Select ESF or %ESF on the Results Display	2-7
To Emulate a DTE or DCE	2-7
DTE Emulation	2-8
DCE Emulation	2-9
To Set up for Asynchronous Operation	2-10
To Set up for Synchronous Operation	2-12
To Select the Clock Source (that clocks data out of the Datacom Analyzer)	2-13
To Supply a Clock to the System Under Test (from the Datacom Analyzer)	2-14

To Select the Clock Source (that clocks data into the Datacom Analyzer)	2-15
To Set up Control Circuits (to establish a data path)	2-16
To Select a PRBS or Fixed Pattern	2-17
To Select a FOX Pattern (Asynchronous TX Function Only)	2-18
To Change Transmit and Receive Data Polarity	2-19
To Select a Test Period	2-19
To Insert Errors into the Transmitted Data	2-21
To Set up the Pattern Sync Loss Threshold	2-22
To Select a Block Length	2-22
To Store Results	2-23
To Check Store Status and Delete Results from the Store	2-23
To Store Instrument Settings	2-24
To Run a measurement	2-25
3. Viewing BER Results	
To View Bit Error Results	3-2
To View Alarm Seconds	3-3
To View G.821 Analysis Results (Synchronous Data Only)	3-3
To View TX & RX Rates (Synchronous Data Only)	3-4
To View Results as Graphs	3-5
To View All Error and Alarm Results	3-6
To View Measurement Results in Detail	3-7
To View Current Results as Graphs	3-8
To View Stored Results as Graphs	3-9
To View Stored Results as Text	3-10
4. Printing BER Results and Settings	
Printer Selection	4-2
To Select Baud Rate, Character Format and Pacing	4-2
Cable Connection - (DCE to DTE)	4-3
Using a Hewlett-Packard Printer - HP 2225D ThinkJet	4-3
Using an Alternative (non Hewlett-Packard) Printer	4-6
To Print Current Results and Settings (on demand)	4-8
To Print Current Results as Graphs	4-8
To Print Stored Results	4-9
To Select a Stored Test	4-9
To Print Text Results from the Store	4-10

To Print Graphic Results from the Store 4-10

5. **Using and Checking Control Circuits** 5-2
 To Select the Datacom Interface 5-3
 To Emulate a DTE or DCE 5-4
 To View the Current State of All Control Circuits 5-6
 To Measure RTS-CTS (RS-CS) Delay 5-8
 To Measure the Delay between any Two Events 5-8

6. **General Information** 6-1
 Introduction 6-1
 Specification 6-2
 Safety Considerations 6-2
 Instruments Covered by Manual 6-3
 Options Available 6-4
 Accessories Supplied 6-4
 Accessories Available 6-5
 Specification 6-6
 DATAKOM INTERFACES 6-6
 V.24 6-8
 V.11 6-10
 X.21 Leased 6-11
 V.35 6-13
 V.24 Breakout 6-14
 V.11/V.35/X.21 Leased Activity Indicators 6-15
 TERMINAL EMULATION 6-15
 DTE Mode 6-15
 Data and Clock Circuits: 6-15
 Control Circuits: 6-16
 DCE Mode 6-16
 Data and Clock Circuits 6-16
 Control Circuits 6-17
 TRANSMITTER 6-17
 Synchronous Mode 6-18
 Asynchronous Mode 6-18
 Transmitter Facilities 6-18
 Error Add 6-18
 RECEIVER 6-19

Synchronous Mode	6-19
Asynchronous Mode	6-19
Receiver Facilities	6-19
Pattern Sync	6-20
Receiver Alarms	6-21
Beep on Error	6-21
PATTERNS	6-22
MEASUREMENTS	6-23
Measurement Types	6-23
BER Measurement Operation	6-23
Test Period	6-24
Bit Error Results	6-24
Alarm Duration	6-24
Frequency	6-24
Control Circuit Timing	6-25
G.821 ANALYSIS	6-26
STORED MEASUREMENT GRAPHICS	6-27
Graphs	6-27
Text Results	6-28
Storage	6-29
TIME FUNCTIONS	6-29
Real-Time Clock	6-29
Elapsed Time	6-30
STORED SETTINGS	6-30
DATA LOGGING	6-30
PRINTER & REMOTE CONTROL PORT	6-31
USER CONFIDENCE TESTS	6-31
POWER SUPPLY	6-31
PHYSICAL	6-32
Dimensions	6-32
Weight	6-32
Environment	6-32

7. Installation

Introduction	7-1
Initial Inspection	7-1
Preparation for Use	7-2
Power Requirements	7-2
Line Fuses	7-2
Power Cable	7-3
Battery (Option B12)	7-3
To Charge the Batteries (Option B12)	7-4
To Change the Batteries	7-4
Battery Fuses	7-5
To Change a Blown Fuse	7-5
Mating Connectors (Front Panel)	7-6
Installing the Datacom Module	7-7
ACCESSORY Port - for Datacom Module Connection	7-7
RS-232 Port - for Printer or Remote Control Connection	7-7
Modem Connection	7-9
Rack Mounts	7-10
Operating Environment	7-11
Storage and Shipment	7-11
Environment	7-11
Packaging	7-12

8. Performance Tests

Introduction	8-1
Calibration Cycle	8-1
Recommended Test Equipment	8-2
Datacom Module Self Test	8-3
Datacom Module Self Test, Order and Fail Codes	8-6
Internal Synthesizer Rates	8-7
Test Record	8-10

9. Remote Control

Preparation for Remote Control	9-1
To Connect to Telephone Lines via Modems	9-2
To Connect for Direct Operation	9-3
To Set the Analyzer for Operation from a Terminal	9-4
To Set the Analyzer for Operation from a Computer	9-5

Remote Operation	9-6
Terminal Control	9-7
Prompting and Input Editing	9-8
The Prompt	9-8
Input Editing	9-8
Error Reporting	9-8
Mnemonic Responses	9-9
HP-IB Operation (option H02)	9-11
Connecting to the HP-IB	9-12
Operating Distances	9-12
Hewlett-Packard Interface Bus Connector	9-12
Suitable Cables	9-13
Connection Over Greater Distances	9-14
Setting Up for Printing or Controlling	9-14
To Print using Talk Only	9-14
To Control the Instrument Remotely	9-14
Communication with the System Controller	9-14
HP-IB Address Selection	9-15
To Return to Local Operation	9-15
Status Reporting	9-15
Service Request Interrupt Routine	9-16
Poll Using STB?	9-16
HP-IB Capability	9-16
HP-IB Universal Commands	9-17
Programming Tips	9-19
THE COMMANDS	9-21
COMMON CAPABILITY MESSAGES	9-21
Reset	9-21
Remote	9-21
Local	9-21
Clear	9-22
Configuration	9-22
Key Query	9-23
Request Service Mask	9-23
Instrument Identification	9-25
Revision Date Query	9-25
Serial Number Query	9-25
Error Code Query	9-26

Ready Code Query	9-26
Status/Events Query	9-26
Status Query	9-26
Options Query	9-27
Self-test	9-27
Accessory Identification Query	9-27
Accessory Revision Date Query	9-27
INSTRUMENT SETTINGS COMMANDS	
Datacom Interface Type	9-29
Emulation Type	9-29
Timing Type	9-29
Asynchronous Character Length	9-30
Asynchronous Parity	9-30
Asynchronous Stop Bits	9-31
Transmit Clock Source	9-31
Transmit Clock Source Sense	9-31
Receive Clock Source	9-32
Receive Clock Source Sense	9-32
Asynchronous Data Rate	9-33
Synchronous Data Rate	9-34
User Program Synchronous Data Rate	9-35
Pattern Type	9-35
Pattern Polarity	9-36
<hr/>	
User Defined Word Pattern	9-36
Display EFS or %EFS Result	9-36
OTHER-PAGE DATACOM SETTINGS	
Transmit Data Polarity	9-37
Receive Data Polarity	9-37
Transmit Output Clock Sense	9-37
Receiver Sync Gain Control	9-38
Sync Loss AUTO Resync Threshold	9-38
FOX Character Code	9-39
FOX Flow Control	9-39
Audio Source (Beep On Error)	9-40
ERROR ADDITION COMMANDS	
Error Add Rate	9-41
Single Error Add	9-41

TEST PERIOD AND RESULT CONFIGURATION

COMMANDS	9-42
Block Length	9-42
Test Period Type	9-42
Single Test Period Duration	9-43
Bit Test Duration	9-43
CONTROL CIRCUIT TIMING COMMANDS	9-44
Control Circuit Timing Trigger	9-44
Control Circuit Timing RANGE	9-44
Control Circuit Timing DELAY A-B	9-45
Control Circuit Timing Delay Edge-A	9-45
Control Circuit Timing Delay Edge-A Sense	9-46
Control Circuit Timing Delay Edge-B	9-46
Control Circuit Timing Delay Edge-B Sense	9-46
Control Circuit Timing Trace Enable	9-47
Control Circuit Timing Status	9-47
Control Circuit Timing Line Status	9-48
Control DCE CTS/CS/I Circuits	9-48
Control DCE DSR/DM Circuits	9-48
Control DCE DCD/RR/RLSD Circuits	9-49
Control DTE RTS/RS/C Circuits	9-49
Control DTE DTR/TR Circuits	9-50
RESULT QUERY COMMANDS	9-50
Basic Results Query	9-51
Bit Analysis Results Query	9-51
Alarm Seconds Results Query	9-52
Frequency Results Query	9-52
Delay Measurement Query	9-52
Elapsed Bit Result Query	9-53
Control Circuit Timing Data	9-53
Control Circuit Timing Compressed Data Query	9-54
STORED MEASUREMENT AND GRAPHICS QUERY COMMANDS	9-56
Stored Graphical Data Query	9-56
Stored Graphical Data in Compressed Form Query	9-57
Stored Telecom/Datacom Mode	9-58
Stored Interface Type	9-58
Stored Emulation Type	9-59

Stored Timing Type	9-59
Stored Asynchronous Character Length	9-59
Stored Asynchronous Parity	9-60
Stored Asynchronous Stop Bits	9-60
Stored Transmit Clock Source	9-60
Stored Receive Clock Source	9-60
Stored Asynchronous Data Rate	9-61
Stored Synchronous Data Rate	9-61
Stored User Program Synchronous Data Rate	9-61
Stored Pattern Type	9-62
Stored User Defined Word Pattern	9-62
Stored Pattern Polarity	9-62
Stored Transmit Data Polarity	9-62
Stored Receive Data Polarity	9-63
Stored Block Length	9-63
Stored Receiver Sync Gain Control	9-63
Stored Sync Loss AUTO Resync Threshold	9-64
Stored Basic Results Query	9-64
Stored Bit Analysis Results Query	9-65
Stored Alarm Seconds Results Query	9-65
Stored Elapsed Bits	9-66
KEYBOARD FUNCTION COMMANDS	9-67
Telecom/Datacom Mode	9-67
Manual Resync	9-67
Error Codes	9-68
Print Now	9-68
Common Capability Errors	9-68
Parse Time Errors (Error codes -100 to -199)	9-68
Execution Time Errors (Error codes -200 to -299)	9-69
Stored Measurement Results and Graphics Errors (Error codes -410 to -499)	9-69
Option or Capability Errors (Error codes -600 to -699)	9-70
Self-Test Errors (Error codes 700 to 1599)	9-70
Status Registers	9-71
STATUS REGISTER A	9-71
STATUS REGISTER B	9-74
READY REGISTER	9-76
ALARM REGISTER	9-77

Default Conditions 9-79

A. Synchronous Clock Configurations

- Your Datacom Analyzer as DTE When your Datacom Analyzer is configured as A-2
- Datacom Analyzer Transmitter Supplies Clock to DCE Under Test A-2
- DCE Under Test Supplies Clock to Datacom Analyzer Transmitter A-3
- Your Datacom Analyzer as DCE A-4
- DTE Under Test Supplies Clock to Datacom Analyzer Receiver Datacom Analyzer Transmitter Supplies Clock to Datacom Analyzer Receiver A-5
- DTE Under Test Supplies Clock to Datacom Analyzer Receiver and Transmitter A-6

B. Bit Error Results

C. G.821 Analysis

D. Alarms

Index

Instrument Description

This lightweight, rugged portable Datacom Analyzer provides BER measurements and control circuit timing analysis for manufacturing, installing and troubleshooting datacom circuits and equipment. Some of the main features and benefits of the Datacom Analyzer are listed below:

- Four datacom interfaces V.24, V.11, X.21 and V.35 - (Telecom testing is also provided).
- Datacom rates from 50 bit/s to 2.048 Mbit/s (with a built-in synthesizer).
- Synchronous and asynchronous operation.
- Emulates a DTE - for testing data circuits, or a DCE for testing datacom terminal equipment.
- V.24 breakout facility - helps solve configuration and cabling problems.
- Control circuit timing analysis - identifies faulty interfaces, gives more reliable finger pointing between datacom circuits and terminal equipment.
- On screen graphic presentation of results - helps with the interpretation of long-term tests.
- Results storage - allows results to be viewed or printed later.
- RS-232 remote control - allows for easy integration into network monitoring or manufacturing test systems.

Getting Started

Introduction

This chapter aims to quickly get you using the Datacom Analyzer by taking you step-by-step through instrument switch-on and the following demonstrations:

- Making a Measurement on Asynchronous Data
- Making a Measurement on Synchronous Data
- Measuring RTS/CTS Delay

In these demonstrations the instrument is looped back to itself so that no external equipment is needed. This is done using the V.24 breakout facility to interconnect the appropriate interface circuits (see each demonstration for details). All demonstrations start with the instrument set to its default settings.

Before progressing to *Switch-on* and the demonstrations, review the front panel features shown on the page opposite.

Switch-On

Caution



Before powering on the instrument, ensure the Datacom Module cable is properly connected to the **ACCESSORY** connector on the side panel. Do not connect or disconnect the cable while the instrument is switched on.

Connect the ac power cord, then switch on. The standard and battery Option B12 instrument side panels are shown below.

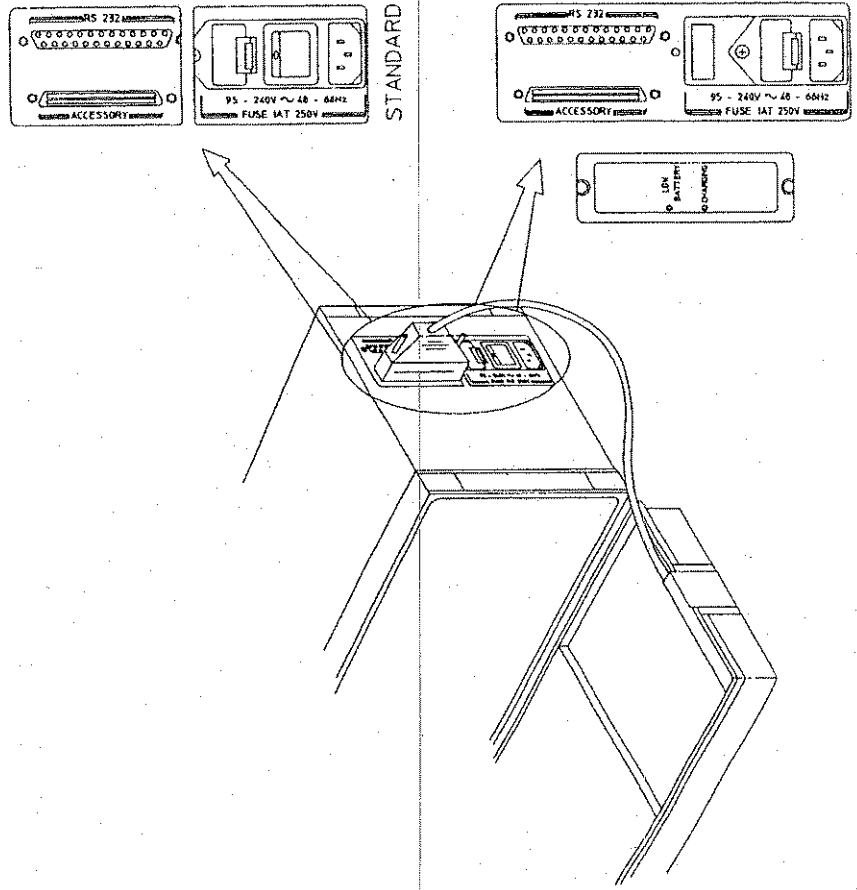

The instrument goes through initialization while displaying the following for approximately 5 seconds.

During this period, indicators may light and the audio monitor may beep.

If the instrument is fitted with Option B12 (for battery operation), the green CHARGING indicator on the side panel will also be lit. For more information on the Battery Option, see page 7-3.

After initialization the instrument establishes the settings it had prior to the last power down.

Check the status of the TEST SELECT indicators on the Datacom Module.

If TELECOM is lit, press the TEST SELECT key - this re-runs initialization then configures the instrument as a Datacom Analyzer. The DATACOM indicator will light after initialization is complete.

The next stage in *Getting Started* is to establish the instrument default settings - the starting point for the three demonstrations.

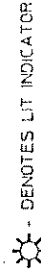
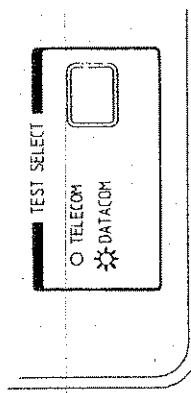
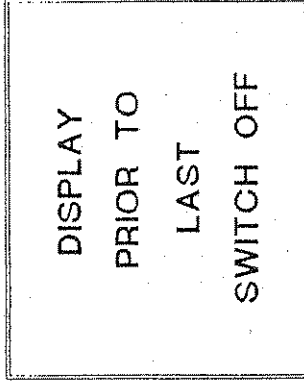
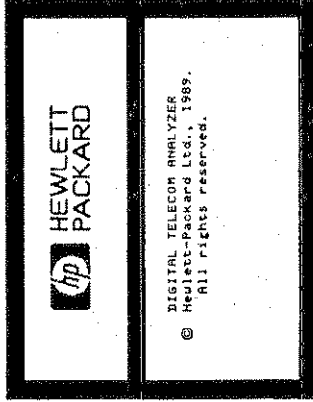

To Select the Datacom Default Settings

Press **OTHER** then **STORED SETTINGS**.

```

FUNCTION          [ STORED SETTINGS ]
STORED SETTING NUMBER [ 0 ]
ACTION           [ OFF ]
SETTING 0 FACTORY DEFAULT SETTINGS
1 .....
2 .....
3 .....
4 .....
5 .....
STATUS:
STORED SETTINGS
DATA COM
MAGNETIC PORT
DISK
DRIVE
    
```

Use the cursor keys to highlight the **STORED SETTING NUMBER** setting, then select **0**.

```

FUNCTION          [ STORED SETTINGS ]
STORED SETTING NUMBER [ 0 ]
ACTION           [ OFF ]
SETTING 0 FACTORY DEFAULT SETTINGS
1 .....
2 .....
3 .....
4 .....
5 .....
STATUS:
0
1
2
3
4
5
MORE
    
```

Highlight the ACTION setting, then press RECALL to establish the factory default settings.

When you press RECALL, the display blanks for a few seconds, the audio monitor may beep then the STORED SETTINGS are displayed again. The message Recalling panel ... is displayed for a few seconds.

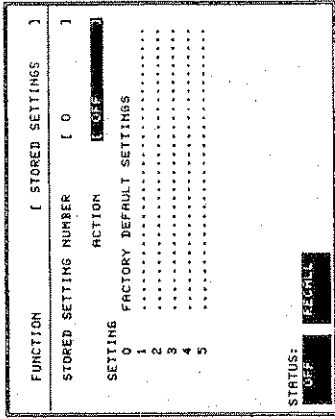

The status of the Datacom Module indicators are as shown below. If the V.24 indicators are not as shown, check that the breakout isolating switches are set to their CLOSED position. Also ensure that no wires are interconnecting patch points.

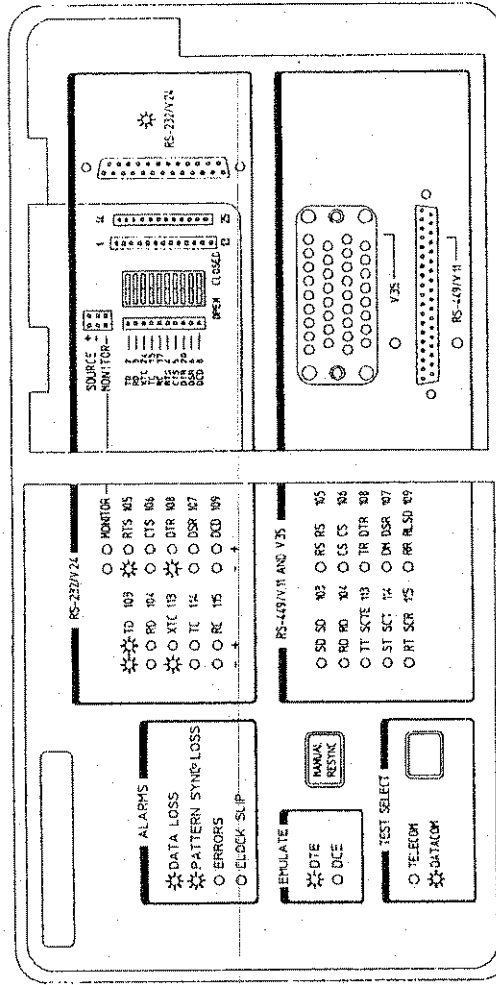

★ - DENOTES LIT INDICATOR

To Choose EFS or %EFS as the Current Results Display

During a test EFS or %EFS can be displayed. Printouts and stored results show both EFS and %EFS.

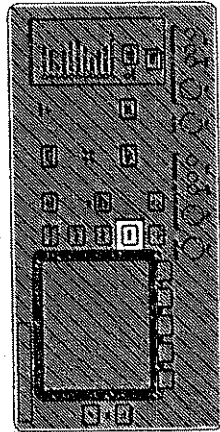

Press **OTHER**

Highlight
DISPLAY EFS OR %EFS

Select **EFS**

MISCELLANEOUS	
FUNCTION	
KEYBOARD LOCK	[OFF]
BEEP ON ERROR	[OFF]
DESELECTED TIMESLOTS	[2^6-1]
DISPLAY EFS OR %EFS	[EFS]

STATUS: ANALYSIS CONTROL LOGS USE MISCELLANEOUS EFS %EFS

You should see

MISCELLANEOUS	
FUNCTION	
KEYBOARD LOCK	[OFF]
BEEP ON ERROR	[OFF]
DESELECTED TIMESLOTS	[2^6-1]
DISPLAY EFS OR %EFS	[%EFS]

STATUS: EFS

Making a Measurement on Asynchronous Data

This demonstration first gets you to initialize the instrument with its default settings. It then shows you how to set up and run a timed BER measurement for a 9600 b/s asynchronous data circuit with a character format of eight data bits, no parity and two stop bits.

The measurement is first run over a 15 second period using a PRBS pattern of 2047 bits with no errors inserted in the transmitted data. The measurement is then re-run with single errors inserted.

A patch wire loops the instrument back to itself to simulate the data circuit.

Procedure

To Initialize the Instrument

Ensure the instrument is configured as a Datacom Analyzer and set to its default settings, as described on pages 1-2 to 1-5.

Press **(SETTINGS)** to highlight the datacom **INTERFACE** setting. If the settings on the display are not as shown, repeat the steps on pages 1-2 to 1-5.

APPLICATION	[DATACOM]
INTERFACE	[BTE] [ASYNC]
CHARACTER LENGTH	[7] STOP BITS [1]
PARITY	[ODD]
TX DATA RATE (ASYNC)	[9600 b/s]
PATTERN	[2*20-1]
BLOCK LENGTH	[NORMAL]
ERROR ADD	[AUTO]
STATUS	[7:54] [3:11] [9:55] [8:21]
	[TEST] [UNTEST] [LEASED]

To Set the Character Format

Use the cursor keys to highlight the data CHARACTER LENGTH, then select **8**.

Highlight the STOP BITS setting, then select **2**.

Highlight the PARITY setting, then select **NONE**.

APPLICATION	[DATACOM]
INTERFACE	[V.24] [DTE] [ASYNC]
CHARACTER LENGTH	[8] [STOP BITS [2]]
PARITY	[NONE]
TX DATA RATE (ASYNC)	[9600 b/s]
PATTERN	[2-20-1] [NORMAL]
BLOCK LENGTH	[AUTO]
ERROR ADD	[SINGLE]
STATUS:	[5] [0] [0] [0]

To Set the Pattern

Use the cursor keys to highlight the PATTERN setting, then select **2047 BITS**.

APPLICATION	[DATACOM]
INTERFACE	[V.24] [DTE] [ASYNC]
CHARACTER LENGTH	[8] [STOP BITS [2]]
PARITY	[NONE]
TX DATA RATE (ASYNC)	[9600 b/s]
PATTERN	[2047 BITS] [NORMAL]
BLOCK LENGTH	[AUTO]
ERROR ADD	[SINGLE]
STATUS:	[5] [0] [0] [0]

To Set the Test Period

Press **RESULTS** followed by **BASIC RESULTS**. Highlight the **TEST PERIOD** setting, then select **SINGLE - 10 SECONDS** will appear on the display.

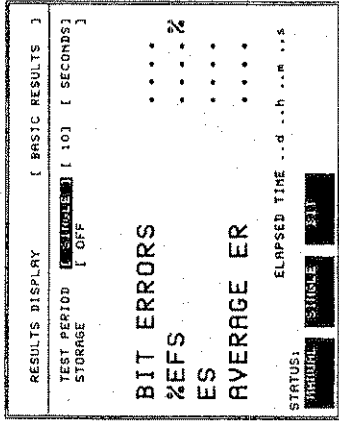

Use the cursor keys to highlight the 1 of the 10.

Use the right arrow key at the bottom of the display to select 0

Use **INCREASE DIGIT** until 15 is displayed.

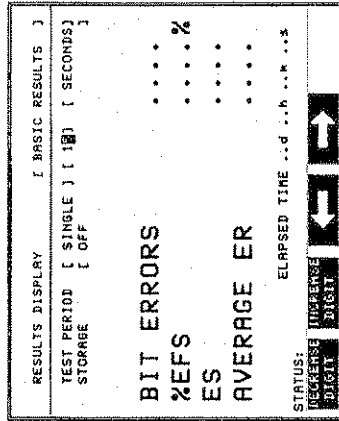

Connect the Patch Wire

Connect the the patch wire as shown.

Ensure all isolating switches are set to their **CLOSED** position then check that:

The green **SIGNAL PRESENT** indicator lights.

The red **SIGNAL LOSS** and **PATTERN LOSS** alarm indicators go out.

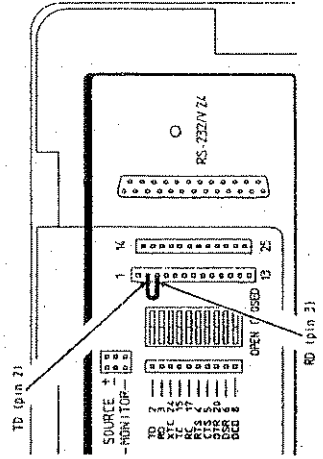

Check the Datacom Module V.24 indicators are as follows.

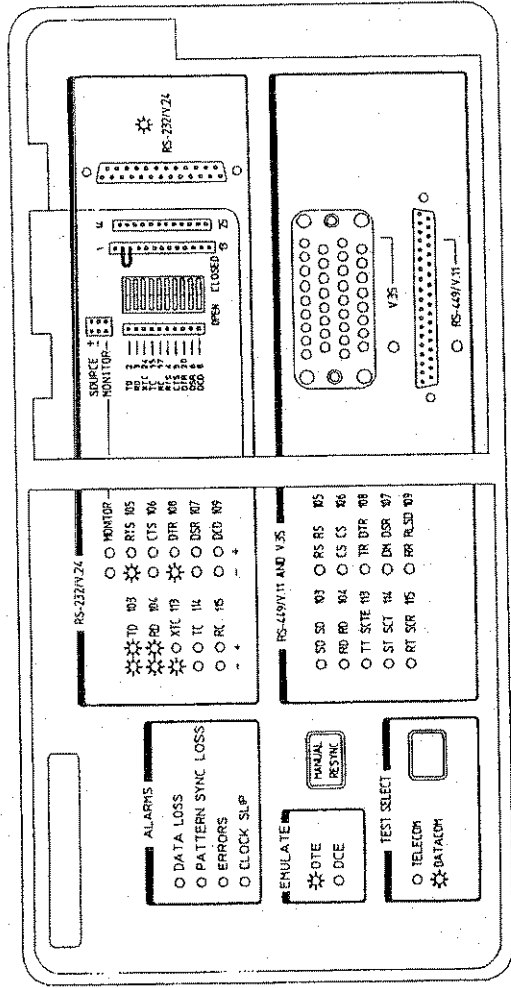

- DENOTES LIT INDICATOR

To Run the Measurement

Press **START/STOP** - the green **START/STOP** indicator lights and the **ELAPSED TIME** at the bottom right of the display increments in 1 second steps to 15.

At 15 seconds the measurement stops - the **START/STOP** indicator goes out and the display is as shown.

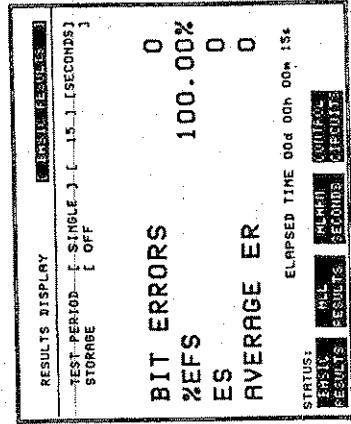

To Insert Single Errors

Press **(START/STOP)** to start the measurement then press the **(SINGLE ERROR ADD)** key repeatedly, note how the displayed error result increments each time the key is pressed. A typical display is shown opposite.

RESULTS DISPLAY	[BASIC RESULTS]
TEST PERIOD [SINGLE] [148] [SECONDS]	
STORAGE [OFF]	
BIT ERRORS	12
%EFS	46.67%
ES	8
AVERAGE ER	1.1E-04
STATUS:	ELAPSED TIME 00h 00m 00s 15s
DECREASE BIT	←
INCREASE BIT	→

You have now completed a measurement on asynchronous data.

Making a Measurement on Synchronous Data

This demonstration first gets you to initialize the instrument with its default settings. It then shows you how to set up and run a BER measurement over 10^6 bits for a 56 kb/s synchronous data circuit.

The measurement is first run using a $2^{15}-1$ PRBS pattern with no errors being inserted into the transmitted data. The measurement is then re-run with errors being inserted at a fixed rate of 1 error every 10^3 bits.

Two patch wires loop the instrument back to itself to simulate the data circuit.

Procedure

To Initialize the Instrument

Ensure the instrument is configured as a Datacom Analyzer and set to its default settings, as described on pages 1-2 to 1-5.

Press **(SETTINGS)** to highlight the datacom INTERFACE setting. If the settings on the display are not as shown, repeat the steps on pages 1-2 to 1-5.

APPLICATION	[DATACOM]
INTERFACE	[DTE] [ASYNC]
CHARACTER LENGTH	[7] STOP BITS [1]
PARITY	[ODD]
TX DATA RATE (ASYNC)	[9600 b/s]
PATTERN	[2 ¹⁵ -1]
	[NORMAL]
BLOCK LENGTH	[AUTO]
ERROR ADD	[SINGLE]
STATUS:	[] [] [] [] [] [] [] []
POWER	[] [] [] [] [] [] [] []
TEMP	[] [] [] [] [] [] [] []
INTERF	[] [] [] [] [] [] [] []
LEALED	[] [] [] [] [] [] [] []

To Set the Instrument for Synchronous Data

Use the cursor keys to highlight **ASYN**, then select **SYNC**.

APPLICATION	(DATACON)
INTERFACE	[V.24] [DTE] [ASYN]
TX CLOCK SOURCE	(INTERNAL) [(]
RX CLOCK SOURCE	(INTERFACE) [(]
TX OUTPUT CLOCK SENSE	() [(]
PATTERN	[2*20-1] []
BLOCK LENGTH	[NORMAL] []
ERROR ADD	[AUTO] []
	[SINGLE] []
STATUS:	
ASYN	SYNC

To Set the Data Rate

Use the cursor keys to highlight the **TX CLOCK SOURCE** setting, then select **INTERNAL**. A **TX DATA RATE (SYNC)** of **9600 b/s** will appear on the display.

APPLICATION	(DATACON)
INTERFACE	[V.24] [DTE] [SYNC]
TX CLOCK SOURCE	[INTERNAL] [(]
RX CLOCK SOURCE	(INTERFACE) [(]
TX OUTPUT CLOCK SENSE	() [(]
TX DATA RATE (SYNC)	[9600 B/S] []
PATTERN	[2*20-1] []
BLOCK LENGTH	[NORMAL] []
ERROR ADD	[AUTO] []
	[SINGLE] []
STATUS:	
INTERNAL	INTERNAL

Highlight the **TX DATA RATE (SYNC)** setting, then select **56 kb/s**.

APPLICATION	(DATACON)		
INTERFACE	[V.24] [DTE] [SYNC]		
TX CLOCK SOURCE	(INTERNAL) [(]		
RX CLOCK SOURCE	(INTERFACE) [(]		
TX OUTPUT CLOCK SENSE	() [(]		
TX DATA RATE (SYNC)	[56 KB/S] []		
PATTERN	[2*20-1] []		
BLOCK LENGTH	[NORMAL] []		
ERROR ADD	[AUTO] []		
	[SINGLE] []		
STATUS:			
56	48	19.2	1000
KB/S	KB/S	KB/S	KB/S

To Set the Pattern

Use the cursor keys to highlight the PATTERN setting, press MORE, then select 2-15-1.

APPLICATION	[DATACOR]
INTERFACE	[V.24] [DTE] [SYNC]
TX CLOCK SOURCE	[INTERNAL]
RX CLOCK SOURCE	[INTERFACE] [1]
TX OUTPUT CLOCK SENSE	[1]
TX DATA RATE (SYNC)	[64 kb/s] [1]
PATTERN	[2-15-1] [NORMAL]
BLOCK LENGTH	[AUTO]
ERROR ADD	[SINGLE]
STATUS:	ERR: 00000000 ALY: 00000000

To Set the Test Period

Press (RESULTS) followed by BASIC RESULTS. Highlight the TEST PERIOD setting, then select BIT. A LENGTH setting of 1E4 bits will appear on the display.

RESULTS DISPLAY	[BASIC RESULTS]
TEST PERIOD STORAGE	[BIT] [LENGTH [1E4]]
BIT ERRORS	0
%EFS%
ES
AVERAGE ER
ELAPSED BITS	0
STATUS:	ERR: 00000000 ALY: 00000000

Highlight 1E4, then select 1E6 (10⁶ bits).

RESULTS DISPLAY	[BASIC RESULTS]
TEST PERIOD STORAGE	[BIT] [LENGTH [1E6]]
BIT ERRORS	0
%EFS%
ES
AVERAGE ER
ELAPSED BITS	0
STATUS:	ERR: 00000000 ALY: 00000000

Connect the Patch Wires

Connect the patch wires as shown.

Ensure all isolating switches are set to their **CLOSED** position then check that:

The green **SIGNAL PRESENT** indicator lights.

The red **SIGNAL LOSS** and **PATTERN LOSS** alarm indicators go out.

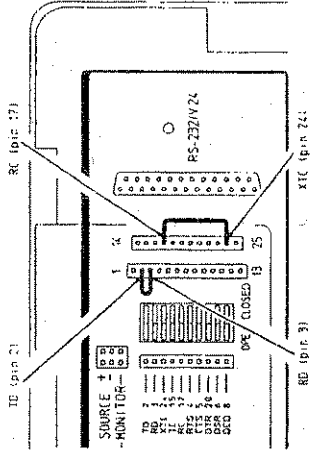

Check that the Datacom Module V.24 indicators are as shown.

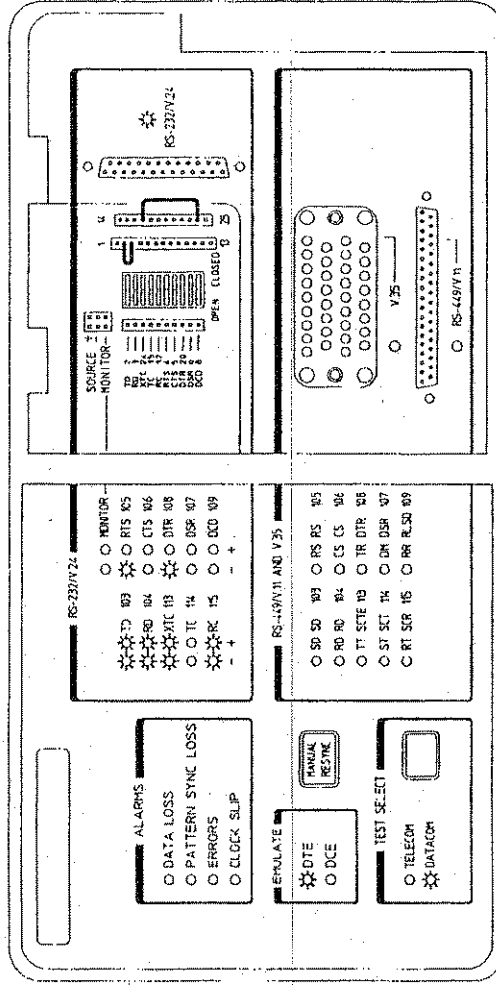

DENOTES LIT INDICATOR

To Run the Measurement

Press **START/STOP** - the green **START/STOP** indicator lights and the **ELAPSED BITS** at the bottom right of the display starts incrementing.

At 10^6 bits the measurement stops - the **START/STOP** indicator goes out, and the display is as shown.

RESULTS DISPLAY	[BASIC RESULTS]
TEST PERIOD [BIT]	LENGTH [1024]
STORAGE [OFF]	
BIT ERRORS	0
%EFS	100.00%
ES	0
AVERAGE ER	0
STATUS:	ELAPSED BITS 1.000E+06
[1E-3]	[1E-3]
[1E-3]	[1E-3]
[1E-3]	[1E-3]

To Insert Errors at a Fixed Rate

Press **SETTINGS**. Highlight the **ERROR ADD** setting, then select **1E-3** (one error in every 10^3 bits).

APPLICATION	[DTRACOM]
INTERFACE	[V.24] [DTE] [SYNC]
TX CLOCK SOURCE	[INTERNAL]
PX CLOCK SOURCE	[INTERFACE]
TX OUTPUT CLOCK SENSE	[1]
TX DATA RATE (SYNC)	[56 KB/S]
PATTERN	[2-15-1] [NORMAL]
BLOCK LENGTH	[AUTO]
ERROR ADD	[1E-3]
STATUS:	[1E-3] [1E-3] [1E-3] [1E-3]
[1E-3]	[1E-3]
[1E-3]	[1E-3]

Press **RESULTS**, then **START/STOP** to start the measurement.

The displayed errors increment at a rate of 1 in 10^3 . At the end of the measurement the displayed results are as shown.

RESULTS DISPLAY	[BASIC RESULTS]
TEST PERIOD [BIT]	LENGTH [1024]
STORAGE [OFF]	
BIT ERRORS	1000
%EFS	0.00%
ES	17
AVERAGE ER	1.0E-03
STATUS:	ELAPSED BITS 1.000E+06
[1E-3]	[1E-3]
[1E-3]	[1E-3]
[1E-3]	[1E-3]

Measuring RTS/CTS Delay

This demonstration first gets you to initialize the instrument to its default settings. It then shows you how to set up and measure the delay between RTS and CTS control circuits.

As a real data circuit is not used in this demonstration, the RTS/CTS delay is simulated using a patch wire and the CTS isolating switch.

The delay is induced by you changing the CTS switch setting from *OPEN* to *CLOSED*. As the delay will be in the order of *seconds*, the instrument is set for the longest sweep range.

Procedure

To Initialize the Instrument

Ensure the instrument is configured as a Datacom Analyzer and set to its default settings, as described on pages 1-2 to 1-5.

Press **(SETTINGS)** to highlight the datacom **INTERFACE** setting. If the settings on the display are not as shown, repeat the steps on pages 1-2 to 1-5.

APPLICATION	(DATACOM)
INTERFACE	(OPEN) (RTS/CTS) (ASYNC)
CHARACTER LENGTH	(7) (STOP BITS [1])
PARITY	(ODD)
TX DATA RATE (RSYNC)	(9600 B/S)
PATTERN	(2-20-1) (NORMAL)
BLOCK LENGTH	(AUTO)
ERROR ADD	(SINGLE)
STATUS:	(V-11) (W-35) (JERR) (UNTRM) (LEASD)

To Select Control Circuit Timing

Press **RESULTS**, then select **CONTROL CIRCUITS**.

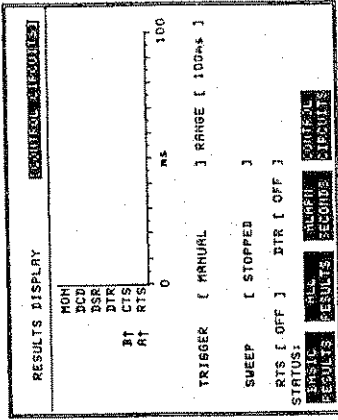

To Set the Sweep Trigger

Use the cursor keys to highlight the **TRIGGER** setting, then select **SINGLE ON A**.

An **A** will appear next to **RTS** on the graph - this indicates that a positive edged **RTS** signal is required to trigger the sweep.

Similarly, a **B** will appear next to **CTS** on the graph - this indicates that the delay measurement will end when a positive edge is detected on the **CTS** signal.

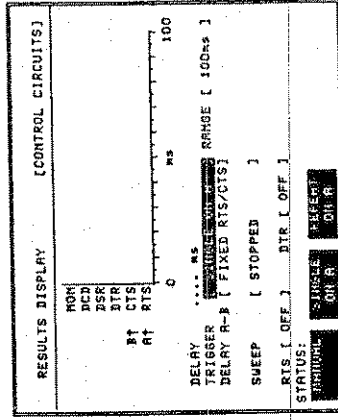

To Set the Sweep Range

Highlight the RANGE setting, then press 10s - the period for which the instrument will sweep once it has been triggered.

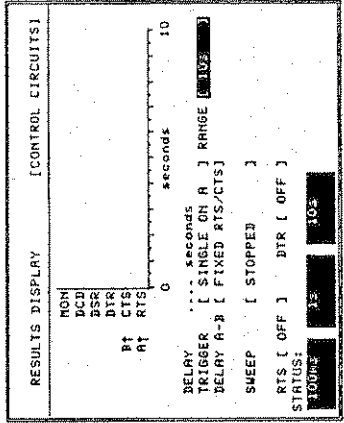

To Set the CTS Control Circuit

Set the CTS isolating switch to its OPEN position.

Connect a patch wire between the + SOURCE and the pin 5 (CTS) patch point.

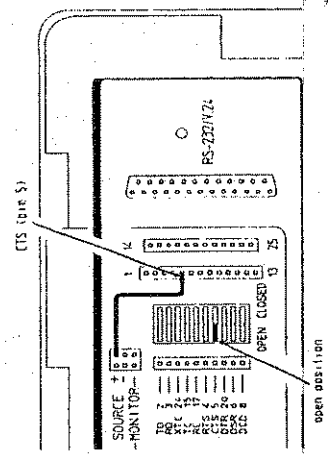

To Run the Sweep

Highlight the SWEEP setting, then press RUN - the sweep and delay measurement will not start until triggered by a positive edge on RTS.

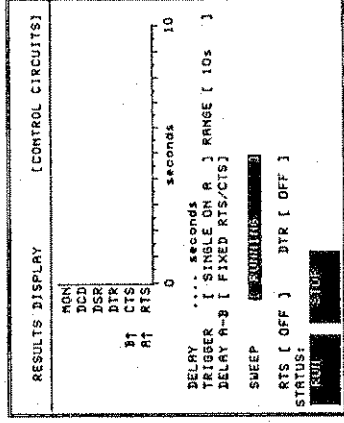

To Measure RTS/CTS Delay

The following steps get you to trigger the sweep then set CTS high. To measure the delay, these two actions must be carried out within the 10 second sweep period.

1. Highlight the RTS setting, then press **ON** - the sweep is triggered by RTS going high.
2. Set the **CTS** switch to its **CLOSED** position within 10 seconds - this produces a positive edge on **CTS**. The displayed **RTS/CTS** delay will be shown graphically and as a numeric result 10 seconds after RTS is set to **ON**. In this demonstration, the displayed delay is 5.175 seconds - the time between **RTS** and **CTS** going high.

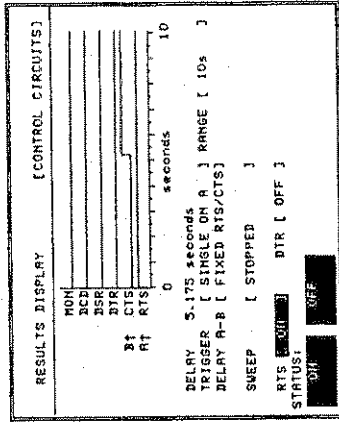

You have now completed the RTS/CTS delay measurement.

Making BER Measurements

This chapter describes the tasks you may need to do to run a datacom BER measurement. To access tasks quickly, refer to the following list of datacom test issues for page references.

Is the instrument configured for datacom testing?	page 2-2
Do you want to use a set of stored instrument settings?	page 2-3
Which datacom interface is to be used?	page 2-4
Is the Datacom Analyzer to emulate a DTE or DCE?	page 2-7
Are measurements to be made on asynchronous data?	page 2-10
Are measurements to be made on synchronous data?	page 2-12
Do control circuits need to be set?	page 2-16
Which pattern is to be selected?	page 2-17
Do you want to transmit a FOX pattern?	page 2-18
Do you want normal or inverted data?	page 2-19
Which test period do you want?	page 2-19
Are errors to be inserted into-transmitted data?	page 2-21
When should the Datacom Analyzer lose sync?	page 2-22
What block length should be used for measurements?	page 2-22
Are results to be stored?	page 2-23
Is there free space in the results store?	page 2-23
Do you want to delete results from the store?	page 2-23
Are instrument settings to be stored?	page 2-24
Do you want to run a measurement?	page 2-25

Note

Many tasks cannot be performed while running a BER measurement. If you try the message - Press STOP, then change selection - is displayed.



To Configure the Instrument as a Datacom Analyzer

Power-on the instrument, then check the *TEST SELECT* indicators on the Datacom Module. If *TELECOM* is lit the instrument is configured as a Telecom Analyzer, if the *DATAKOM* indicator is lit the instrument is configured as a Datacom Analyzer.

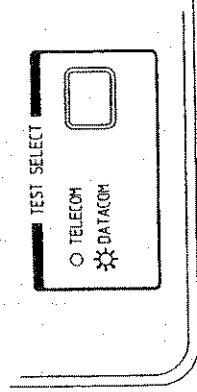

 - DENOTES LIT INDICATOR

To change the instrument configuration, press the *TEST SELECT* key.

To Recall Stored Settings

Press **OTHER** followed by **STORED SETTINGS**.
 Highlight the **STORED SETTING NUMBER**,
 then select the number you want from the
 list of stored settings 0 to 5.

FUNCTION	[STORED SETTINGS]
STORED SETTING NUMBER	[0]
SETTING	ACTION [OFF]
0	FACTORY DEFAULT SETTINGS
1
2
3
4
5
STATUS:	0 1 2 3 4 5 MORE

Highlight the **ACTION** setting, then select
RECALL. Note that the **ACTION** setting
 automatically goes to **OFF** after the
 settings have been recalled.

FUNCTION	[STORED SETTINGS]
STORED SETTING NUMBER	[0]
SETTING	ACTION [OFF]
0	FACTORY DEFAULT SETTINGS
1
2
3
4
5
STATUS:	OFF RECALL

To Select the Datacom Interface

Press **SETTINGS** to highlight the datacom INTERFACE setting.

Listed below are the available settings:

```

V.24
V.11 TERMINATED
V.11 UNTERMINATED
V.35
X.21 LEASED
  
```

APPLICATION:	[DTRCOM]
INTERFACE:	[DTE] [ASYNC]
CHARACTER LENGTH:	[7] [STOP BITS] [1]
PARITY:	[ODD]
TX DATA RATE (ASYNC):	[9600 b/s]
PATTERN:	[2-20-1] [NORMAL]
BLOCK LENGTH:	[AUTO]
ERROR ADD:	[SINGLE]
STATUS:	[V.11] [V.35] [X.21]
	[TERM] [UNTERM] [LEASED]

Only one interface is active at a time.

V.24 Interface with Breakout Facility

Connection to the V.24 interface is through a 25-way D-subminiature connector and Breakout circuit.

To solve control circuit configuration and cabling problems:

- Isolate the circuits-of-interest, by setting the appropriate isolating switches to their *open* position.
 - Use wire links to interconnect the appropriate *patch points*.
- For normal operation all isolating switches must be set to their *closed* position, and all wire links must be removed.

The following two figures illustrate the RS-232/V.24 interface. The first illustrates the actual Datacom Module V.24 interface layout. The second shows the functional layout of the Breakout patch points, isolating switches, and circuit status indicators.

A description of the ten interface circuits implemented are described in *To Emulate a DTE or DCE* on pages 2-7 to 2-9.

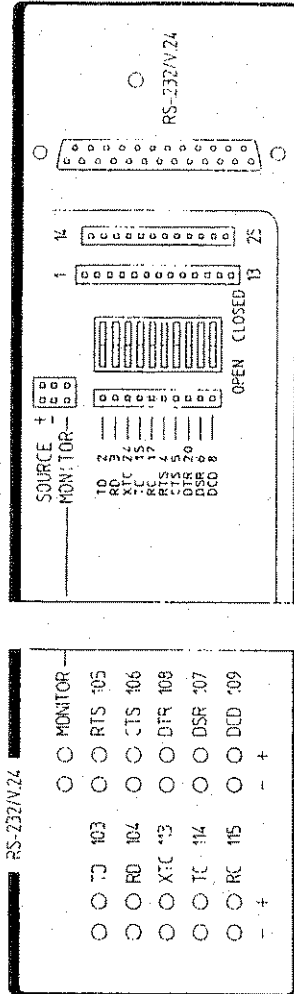

V.24 Front Panel Layout

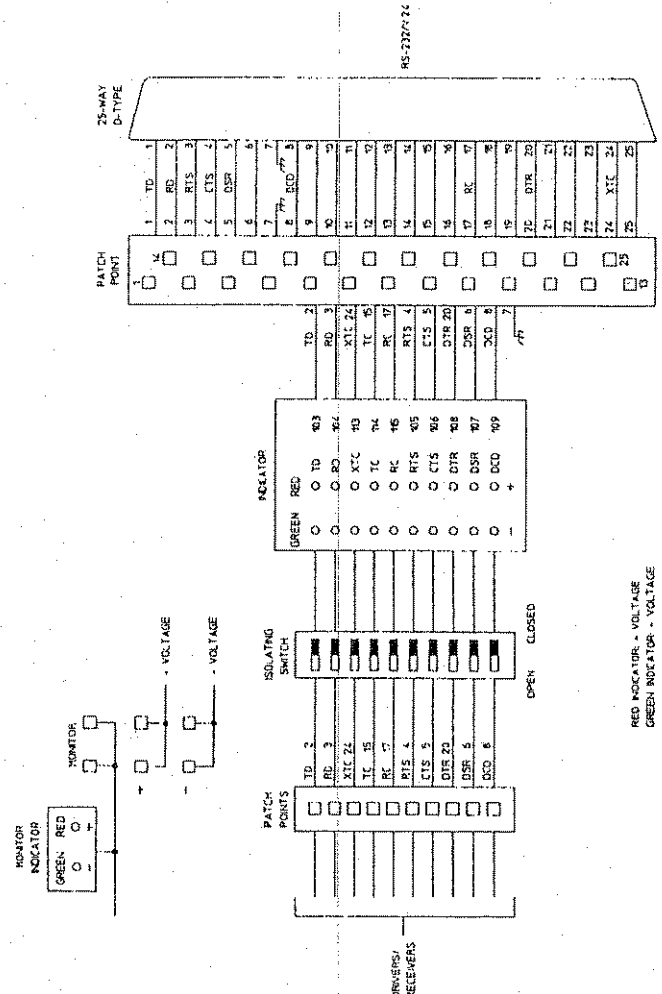

V.24 Functional Layout

RED INDICATOR - VOLTAGE
GREEN INDICATOR - VOLTAGE

V.11 and V.35 Interface

Connection to the V.11 interface is through a 37-way D-subminiature connector. Receivers can be 100Ω terminated or unterminated. Terminated operation is recommended for the higher data rates.

Connection to the V.35 interface is through a 34-pin rectangular connector.

The following figure illustrates the actual Datacom Module RS-449/V.11 and V.35 interface layout.

A description of the ten interface circuits implemented are described in *To Emulate a DTE or DCE* on pages 2-7 to 2-9.

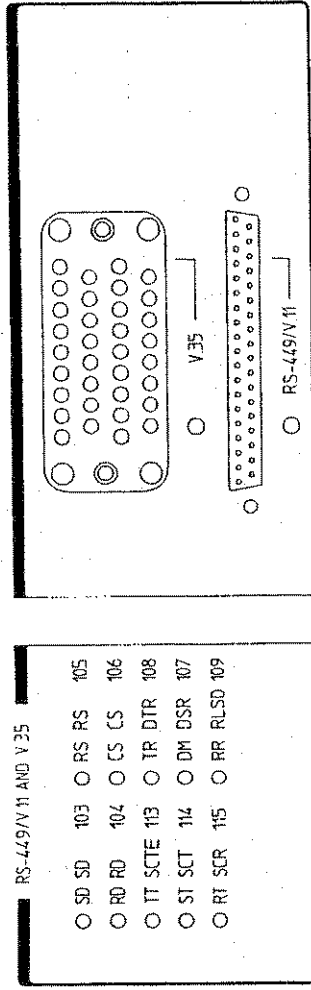

X.21 Leased Interface

Connection to the X.21 Leased interface is through the RS-449/V.11 connector on the Datacom Module using a 15-way to 37-way D-subminiature adapter.

A description of the five interface circuits implemented are described in *To Emulate a DTE or DCE* on pages 2-7 to 2-9.

To Select ESF or %ESF on the Results Display

ESF and %ESF are both available and both are stored and printed. One of the values is displayed on the BER MEASUREMENT RESULTS display. To select ESF or %ESF on this display use **OTHER** MISCELLANEOUS.

To Emulate a DTE or DCE

Press **SETTINGS**, then use the cursor key to highlight the terminal emulation setting (DTE or DCE).

APPLICATION	(DATACOM)
INTERFACE	[V.24]
		DCE	[ASYNC]
CHARACTER LENGTH	[7]
STOP BITS	[1]
PARITY	[ODD]
TX DATA RATE (ASYNC)	[9600 b/s]
PATTERN	[2'20-1]
		NORMAL]
BLOCK LENGTH	[AUTO]
ERROR RFD	[SINGLE]
STATUS:			
		DTE	DCE

When the emulation setting is changed, the *EMULATE* indicators on the Datacom Module change state.

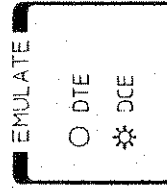

 - DENOTES LIT INDICATOR

DTE Emulation

The data, clock and control circuits are connected as shown below. Control circuits are inputs or outputs and are used to establish a data path, see *To Set up Control Circuits* on page 2-16.

DTE Emulation

	Datacom Interface		
	V.24	V.11	V.35
Data and Clock Circuits			
Transmit Data Out	TD	SD	SD
Receive Data In	RD	RD	RD
Transmit Clock Out	XTC	TT	SCTE
Transmit Clock In	TC	ST	SCT
Receive Clock In	RC	RT	SCR
Control Circuit Outputs			
Request to Send or X.21 Control	RTS	RS	RS
Data Terminal Ready or Terminal Ready	DTR	TR	DTR
Control Circuit Inputs			
Clear to Send or X.21 Indication	CTS	CS	CS
Data Set Ready or Data Mode	DSR	DM	DSR
Data Carrier Detect, Receiver Ready or Rcv Line Signal Det	DCD	RR	RLSD
			I
			-
			-

Pin assignments for each interface is contained in the specification on pages 6-6 to 6-12.

DCE Emulation

The data, clock and control circuits are connected as shown below. Control circuits are inputs or outputs and are used to establish a data path, see *To Set up Control Circuits* on page 2-16.

DCE Emulation

	Datacom Interface			
	V.24	V.11	V.35	X.21
Data and Clock Circuits				
Transmit Data Out	RD	RD	RD	R
Receive Data in	TD	SD	SD	T
Transmit Clock Out	RC	RT	SCR	S
	TC	ST	SCT	-
Transmit Clock In	XTC	TI	SCTE	-
Receive Clock In	XTC	TI	SCTE	-
Control Circuit Outputs				
Clear to Send or X.21 Indication	CTS	CS	CS	I
Data Set Ready or Data Mode	DSR	DM	DSR	-
Data Carrier Detect, Receiver Ready or Rcv Line Signal Det	DCD	RR	RLSD	-
Control Circuit Inputs				
Request to Send or X.21 Control	RTS	RS	RS	C
Data Terminal Ready or Terminal Ready	DTR	TR	DTR	-

Pin assignments for each interface is contained in the specification on pages 6-6 to 6-12.

To Set up for Asynchronous Operation

Note

Asynchronous operation is not available if you are testing at an X.21 Leased interface. X.21 Leased is synchronous operation only.

Press **SETTINGS**, then use the cursor key to highlight the data type setting, then select **ASYNC**.

APPLICATION	[DATACOM]
INTERFACE	[V.24] [DTE] [SERIAL]
CHARACTER LENGTH	[7] STOP BITS [1]
PRIORITY	[ODD]
TX DATA RATE (ASYNC)	[9600 b/s]
PATTERN	[2*20-1]
	[NORMAL]
BLOCK LENGTH	[AUTO]
ERROR ADD	[SINGLE]
STATUS:	[ASYNC]

Configure the character format as follows:

Highlight the data **CHARACTER LENGTH** setting, then select either **8**, **7**, or **6** or **5** bits.

Highlight the **STOP BITS** setting, then select either **1** or **2**.

The **STOP BITS** is fixed at 1.5 if the character length is set for 5 bits.

Highlight the **PRIORITY** setting, then select either **ODD**, **EVEN**, **0's**, **1's**, or **NONE**.

APPLICATION	[DATACOM]
INTERFACE	[V.24] [DTE] [ASYNC]
CHARACTER LENGTH	[8] STOP BITS [2]
PRIORITY	[NONE]
TX DATA RATE (ASYNC)	[9600 b/s]
PATTERN	[2*20-1]
	[NORMAL]
BLOCK LENGTH	[AUTO]
ERROR ADD	[SINGLE]
STATUS:	[ASYNC]

Highlight the TX DATA RATE (ASYNC) setting, then select a rate between 50 b/s and 19.2 kb/s

APPLICATION	(DATA00H	1
INTERFACE	[V.24] [DTE] [ASYNC]	
CHARACTER LENGTH	[8] STOP BITS [1]	
PARITY	[ODD]	
TX DATA RATE (ASYNC)	[5000 B/S]	
PATTERN	[2720-1] [NORMAL]	
BLOCK LENGTH ERROR APP	[AUTO] [SINGLE]	
STATUS:	[5000 B/S] [5000 B/S] [19200 B/S] [NONE]	

To Set up for Synchronous Operation

The main points to consider for synchronous operation are:

Which clock source is to be used to clock data out of the Datacom Analyzer?

Is the Datacom Analyzer to supply a clock to the system under test?

Which clock source is to be used to clock data into the Datacom Analyzer?

Press **SETTINGS** then use the cursor key to highlight the data type setting, then select **SYNC**.

You must now consider what *transmit* and *receive* clock configuration is to be used, details are given in Appendix A *Synchronous Clock Configurations*.

APPLICATION	(DATACOM)
INTERFACE	[V.24] [DTE]
TX CLOCK SOURCE	[INTERFACE] (1)
RX CLOCK SOURCE	[INTERFACE] (1)
TX OUTPUT CLOCK SENSE	[]
PATTERN	[2720-1] [NORMAL]
BLOCK LENGTH	[AUTO]
ERROR ADD	[SINGLE]
STATUS:	SYNC

Note



When the X.21 interface is selected:
The transmit and receive clocks are fixed at **INTERNAL** when the instrument emulates a DCE or **INTERFACE** when the instrument emulates a DTE.

To Select the Clock Source (that clocks data out of the Datacom Analyzer)

Highlight the TX CLOCK SOURCE setting, then select INTERNAL if you want the Datacom Analyzer to supply the clock, or select INTERFACE if you want the system under test to supply the clock.

If the Datacom Analyzer is set for an X.21 LEASED interface, the TX CLOCK SOURCE is fixed at: INTERNAL if the instrument emulates a DCE

or

INTERFACE if the instrument emulates a DTE.

APPLICATION	[DATACOM]
INTERFACE	[V.24] [DTE] [SYNC]
TX CLOCK SOURCE	[INTERNAL]
RX CLOCK SOURCE	[INTERFACE] []
TX OUTPUT CLOCK SENSE	[]
TX DATA RATE (SYNC)	[9600 b/s] []
PATTERN	[2*20-1] []
BLOCK LENGTH	[NORMAL] []
ERROR ADD	[AUTO] []
STATUS:	[]
MODE:	[INTERFACE]

If INTERNAL is selected, then the TX DATA RATE (SYNC) setting will appear on the display (below the TX OUTPUT CLOCK SENSE setting).

Highlight the TX DATA RATE (SYNC) setting then select a rate between 1200 b/s and 1.984 Mb/s (or up to 64 kb/s if the V.24 interface is selected),

or select USER PROGRAM.

If USER PROGRAM is selected, a rate between 600 b/s and 2.048 Mb/s can be set (or up to 128 kb/s if the V.24 interface is selected).

APPLICATION	[DATACOM]
INTERFACE	[V.24] [DTE] [SYNC]
TX CLOCK SOURCE	[INTERNAL]
RX CLOCK SOURCE	[INTERFACE] []
TX OUTPUT CLOCK SENSE	[]
TX DATA RATE (SYNC)	[1.984 Mb/s] []
PATTERN	[2*20-1] []
BLOCK LENGTH	[NORMAL] []
ERROR ADD	[AUTO] []
STATUS:	[]
MODE:	[USER PROGRAM]

If **INTERFACE** is selected, then you can choose which edge of the incoming clock you want to clock data out on. Select \uparrow to clock on the rising edge, or \downarrow to clock on the falling edge.

APPLICATION	(DATACOM)
INTERFACE	[V.24] [SYNC]
TX CLOCK SOURCE	[INTERFACE] []
RX CLOCK SOURCE	[INTERFACE] []
TX OUTPUT CLOCK SENSE	[]
PATTERN	[2-20-1] []
	[NORMAL] []
BLOCK LENGTH	[AUTO] []
ERROR ADD	[SINGLE] []
STATUS:	
TX CLOCK SOURCE	INTERFACE

To Supply a Clock to the System Under Test (from the Datacom Analyzer)

The Datacom Analyzer supplies a clock which can be used to clock data into the system under test. This clock is derived from the selected **TX CLOCK SOURCE**.

Note No clock is available from the Datacom Analyzer if the X.21 LEASED interface is selected and the instrument is emulating a DTE.

Press **(SETTINGS)**, then ensure **SYNC** is selected.

Highlight the **TX OUTPUT CLOCK SENSE** setting, then select \uparrow or \downarrow .

When \uparrow is selected, data is clocked out coincident with the rising edge.

When \downarrow is selected, data is clocked out coincident with the falling edge.

APPLICATION	(DATACOM)
INTERFACE	[V.24] [SYNC]
TX CLOCK SOURCE	[INTERFACE] []
RX CLOCK SOURCE	[INTERFACE] []
TX OUTPUT CLOCK SENSE	[]
PATTERN	[2-20-1] []
	[NORMAL] []
BLOCK LENGTH	[AUTO] []
ERROR ADD	[SINGLE] []
STATUS:	
TX CLOCK SOURCE	INTERFACE

To Select the Clock Source (that clocks data into the Datacom Analyzer)

Press **SETTINGS**, then ensure SYNC is selected.

If the Datacom Analyzer is configured DTE, then RX CLOCK SOURCE is supplied from the INTERFACE only.

APPLICATION	[DTRACOM]
INTERFACE	[V.24] [DTE] [SYNC]
TX CLOCK SOURCE	[INTERFACE] (1)
RX CLOCK SOURCE	[INTERFACE] (1)
TX OUTPUT CLOCK SENSE	[]
PATTERN	[2*20-1]
BLOCK LENGTH	[NORMAL]
ERROR ADD	[AUTO]
	[SINGLE]
STATUS:	
DATE	
TIME	

If the Datacom Analyzer is configured as DCE:

Highlight the RX CLOCK SOURCE setting. Select **INTERNAL** if you want to use the clock supplied by the Datacom Analyzer to the system under test. Select

INTERFACE if you want the system under test to supply the clock.

If the X.21 LEASED interface has been selected, then the RX CLOCK SOURCE is **INTERNAL** only.

APPLICATION	[DTRACOM]
INTERFACE	[V.24] [DCE] [SYNC]
TX CLOCK SOURCE	[INTERFACE] (1)
RX CLOCK SOURCE	[INTERFACE] (1)
TX OUTPUT CLOCK SENSE	[]
PATTERN	[2*20-1]
BLOCK LENGTH	[NORMAL]
ERROR ADD	[AUTO]
	[SINGLE]
STATUS:	
DATE	
TIME	

For both DCE and DTE configurations - when **INTERNAL** or **INTERFACE** is selected, you can choose which clock edge you want to clock data in on. Select **I** to clock on the rising edge, or **F** to clock on the falling edge.

To Set up Control Circuits (to establish a data path)

Before BER testing can proceed, it may be necessary to establish a data path by using the instrument control circuits.

If the instrument is emulating a DTE the circuits are as follows:

DTE Emulation

	V.24	V.11	V.35	X.21
Request to Send	RTS	RS	RS	C
Data Terminal Ready	DTR	TR	DTR	-

If the instrument is emulating a DCE the circuits are as follows:

DCE Emulation

	V.24	V.11	V.35	X.21
Clear to Send	CTS	CS	CS	I
Data Set Ready	DSR	DM	DSR	-
Data Carrier Detect	DCD	RR	RLSD	-

Press **(RESULTS)** followed by **CONTROL CIRCUITS**.

Highlight the control circuit settings then select **ON** and **OFF** as required.

Settings for a typical V.24 interface configured as DCE are shown here.

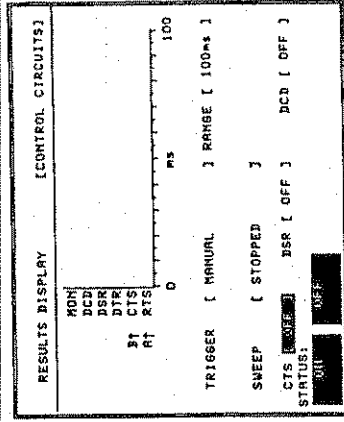

To Select a PRBS or Fixed Pattern

Press **(SETTINGS)**, highlight the **PATTERN** setting then select the pattern that you want:

Pattern

Select

- PRBS 2⁶-1
- PRBS 2⁹-1
- PRBS 2¹¹-1
- PRBS 2¹⁵-1
- PRBS 2²⁰-1
- 63 BITS
- 511 BITS
- 2047 BITS
- 2¹⁵-1
- 2²⁰-1

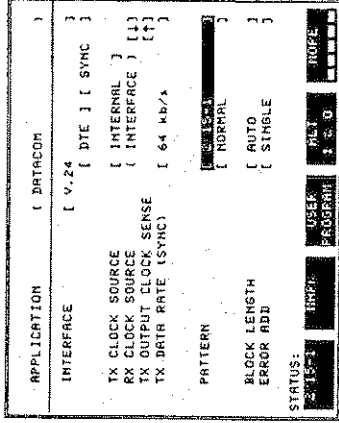

The above patterns can be inverted. Note in Asynchronous operation the *start*, *stop* and *parity* bits are not inverted. If the whole data stream is to be inverted use the DATA POLARITY function, see page 2-19.

All ones

MARK

Alternating mark/space

ALT 1 & 0

User word (16 bits)

USER PROGRAM

If **USER PROGRAM** is selected, a selectable pattern from 3 bits up to 16 bits in length can be set.

Highlight the **WORD LENGTH** setting then use the keys at the bottom of the display to select a word length of between 3 and 16 bits.

Use the cursor keys and the keys at the bottom of the display to set the pattern.

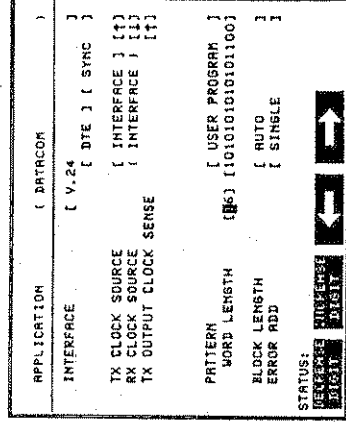

To Select a FOX Pattern (Asynchronous TX Function Only)

Note No measurements can be made using the FOX pattern - its function is to enable you to verify that a terminal or printer is operating correctly.



Press **(SETTINGS)**, highlight the **PATTERN** setting then press **MORE** (twice), then select **FOX**.

APPLICATION	[DATACOM]
INTERFACE	[V.24] [DTE] [ASYNC]
CHARACTER LENGTH	[8] STOP BITS [1]
PARITY	[ODD]
TX DATA RATE (ASYNC)	[19.2 KB/S]
PATTERN	[FOX]
STATUS:	[MORE]

The FOX test pattern has a selectable FOX PATTERN CHARACTER CODE. The codes available depend on the data CHARACTER LENGTH setting. Press **(OTHER)** followed by **TX & RX DATACOM** to access these settings.

FUNCTION	[TX & RX DATACOM]
TRANSMIT DATA POLARITY	[NORMAL]
RECEIVE DATA POLARITY	[NORMAL]
RECEIVER SYNC LOSS THRESHOLD	[AUTO] [LOW] [HIGH]
FOX PATTERN CHARACTER CODE	[ASCII]
FLOW CONTROL	[NONE]
STATUS:	[MORE] [ESCAPE]

Character Length *Code(s)*

8-bit ASCII or EBCDIC

7-bit ASCII

6-bit BCDIC, EBCD

5-bit IPARS or TRANSCODE

 BAUDOT

If the data CHARACTER LENGTH is set to 7 or 8 bits, then the FOX test pattern can be paced by setting the FLOW CONTROL to XON/XOFF.

To Change Transmit and Receive Data Polarity

Press **OTHER** followed by **TX & RX DATACOM**.

Highlight the **TRANSMIT DATA POLARITY** setting, then select **NORMAL** or **INVERTED**.

Highlight the **RECEIVE DATA POLARITY** setting, then select **NORMAL** or **INVERTED**.

FUNCTION	[TX & RX DATACOM]
TRANSMIT DATA POLARITY	[INVERTED]
RECEIVE DATA POLARITY	[NORMAL]
RECEIVER SYNC LOSS THRESHOLD	[AUTO]
FDX PATTERN CHARACTER CODE	[ASCII]
FLOX CONTROL	[NONE]
STATUS:	[NORMAL] [INVERTED]

To Select a Test Period

Press **RESULTS**, highlight the **TEST PERIOD** setting then select either **MANUAL**, **SINGLE** or **BIT**.

If **MANUAL** is selected, the measurement will run continuously when started and can only be stopped with the **START STOP** key. The **ELAPSED TIME** of the measurement is shown at the bottom right of the display.

RESULTS DISPLAY	[BASIC RESULTS]
TEST PERIOD	[MANUAL]
STORAGE	[OFF]
BIT ERRORS
%EFS%
ES
AVERAGE ER
ELAPSED TIME	...d...h...m...s
STATUS:	[NORMAL] [SINGLE] [BIT]

If **SINGLE** is selected, a single measurement will be run over the period you select - from 1 second to 100 days in units of seconds, minutes, hours or days. The **ELAPSED TIME** of the measurement is shown at the bottom right of the display.

To select the timed interval:

Highlight the numeric value using the cursor keys then use the keys at the bottom of the display to select the value you want.

Highlight the time unit, then select either **SECONDS**, **MINUTES**, **HOURS** or **DAYS**.

If **BIT** is selected, a single measurement will be run over the number of bits selected, between 10^4 and 10^{10} bits. The **ELAPSED BITS** of the measurement are shown at the bottom right of the display.

To select the bit interval, highlight the bits value using the cursor keys then select an interval between **1E4** and **1E10**.

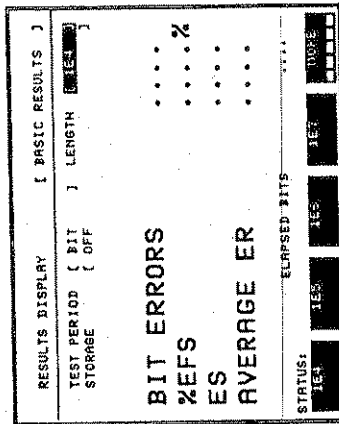
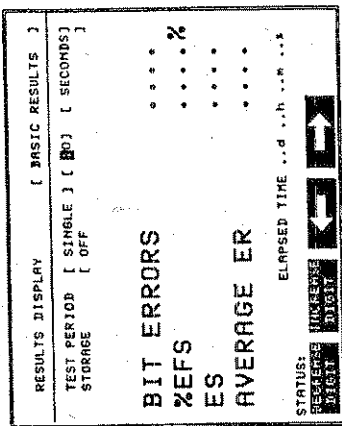

To Insert Errors into the Transmitted Data

If the data transmitted is to have errors inserted at a rate determined by the user:

Press **SETTINGS**, then highlight the **ERROR ADD** setting. If you want errors added at a fixed rate during a test, select **1E-2**, **1E-3**, **1E-4** or **1E-5**.

APPLICATION	[DTRCOM]
INTERFACE	[V.24] [DTE] [SYNC]
TX CLOCK SOURCE	[INTERNAL]
RX CLOCK SOURCE	[INTERFACE]
TX OUTPUT CLOCK SENSE	[56 kb/s]
TX DATA RATE (SYNC)	[56 kb/s]
PATTERN	[2-1S-1] [NORMAL]
BLOCK LENGTH	[AUTO]
ERROR ADD	[1E-3]
STATUS:	[SINGLE] [1E-2] [1E-3] [1E-4] [1E-5]

Select **SINGLE** if you want to add errors singly during a test.

Press the **SINGLE ERROR ADD** key to insert the single errors.

APPLICATION	[DTRCOM]
INTERFACE	[V.24] [DTE] [ASYNC]
CHARACTER LENGTH	[8] [STOP BITS] [1]
PARITY	[ODD]
TX DATA RATE (ASYNC)	[19.2 kb/s]
PATTERN	[2-1S-1] [NORMAL]
BLOCK LENGTH	[AUTO]
ERROR ADD	[SINGLE]
STATUS:	[SINGLE] [1E-2] [1E-3] [1E-4] [1E-5]

To Set up the Pattern Sync Loss Threshold

Press **OTHER** followed by **TX & RX DATA COM**.

Highlight the **RECEIVE SYNC LOSS** setting, then select **AUTO** or **NONE**.

If **AUTO** is selected, then the **THRESHOLD** setting will appear on the display.

Highlight the **THRESHOLD** setting, then select **LOW**, **MEDIUM** or **HIGH**.

FUNCTION	[TX & RX DATA COM]
TRANSMIT DATA POLARITY	[NORMAL]
RECEIVE DATA POLARITY	[NORMAL]
RECEIVER SYNC LOSS THRESHOLD	[AUTO]
FOX PATTERN CHARACTER CODE FLOW CONTROL	[ASCII]
STATUS:	[NONE]

To Select a Block Length

Press **SETTINGS**, highlight the **BLOCK LENGTH** setting (near the bottom of the display), then select **AUTO** or **1E+3 BITS**.

If **AUTO** is selected the block length will be equal to the PRBS length for PRBS patterns. For Fixed patterns, the block length is automatically set to $1E+3 (10^3)$ bits.

APPLICATION	[DATACOM]
INTERFACE	[V.24]
CHARACTER LENGTH	[8]
PARITY	[STOP BITS]
TX DATA RATE (ASYNCR)	[19.2 KB/S]
PATTERN	[2015-1]
BLOCK LENGTH	[AUTO]
ERROR ADD	[SINGLE]
STATUS:	[NONE]

To Measure the Delay between any Two Events

If you are testing synchronous data:

Press **(RESULTS)** followed by **MORE**, then select **CONTROL CIRCUITS**.

OR

If you are testing asynchronous data:

Press **(RESULTS)**, then select **CONTROL CIRCUITS**.

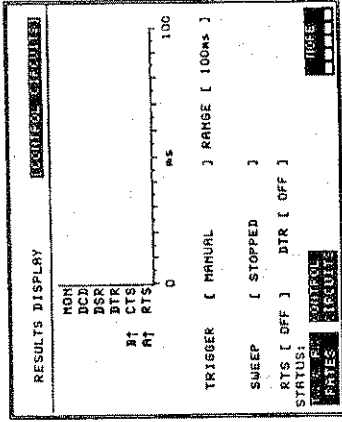

Highlight the **TRIGGER** setting, then select either **SINGLE ON A** or **REPEAT ON A**.

Note that the **DELAY A-B** setting appears on the display - below the **TRIGGER** setting, and that the trigger sense is shown next to the control circuits names on the graph.

If **SINGLE ON A** is selected, then you can view the status of the control circuits when a particular event occurs.

If **REPEAT ON A** is selected, then you can view the status of the control circuits each time a particular event occurs.

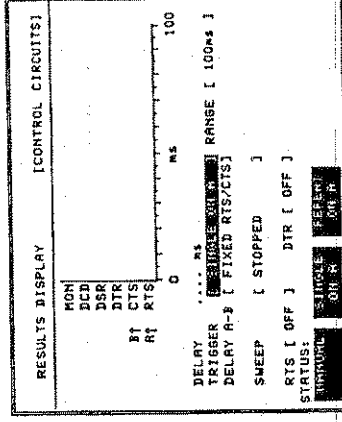

Highlight the RANGE setting, then select the period for which the instrument will sweep, once it has been triggered - either 100ms, 1s or 10s

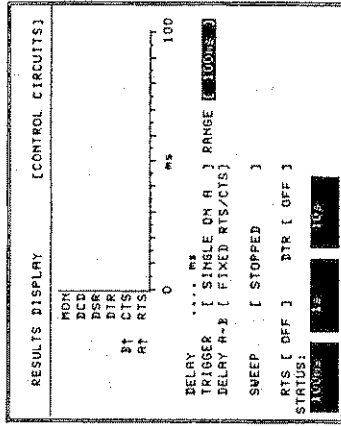

Highlight the DELAY A-B setting, then select FIXED RTS/CTS (for V.24 interface) or FIXED RS/CS (for V.11 or V.35 interface).

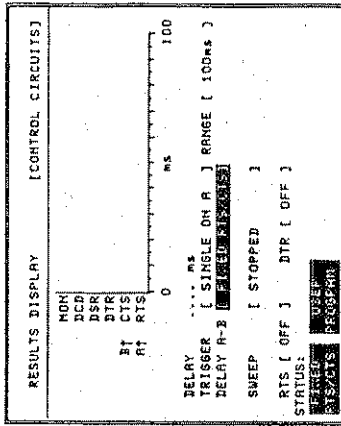

Highlight the SWEEP setting, then select RUN

RUNNING will be displayed until RTS goes high, then for the period selected in the RANGE setting.

The RTS/CTS (RS/CS) delay will then be displayed both graphically and as a measured value.

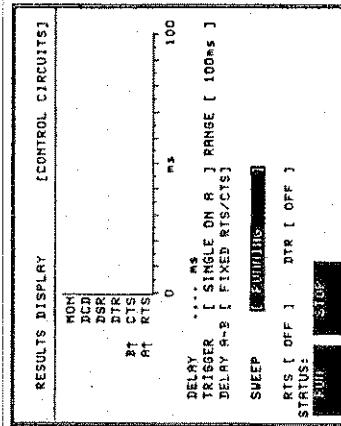

To Measure RTS-CTS (RS-CS) Delay

If you are testing synchronous data:

Press **[RESULTS]** followed by **MORE**, then select **CONTROL CIRCUITS**.

OR

If you are testing asynchronous data:

Press **[RESULTS]**, then select **CONTROL CIRCUITS**.

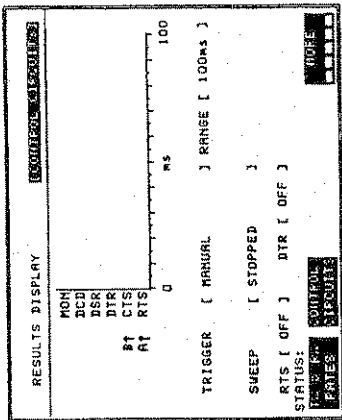

Highlight the **TRIGGER** setting, then select either **SINGLE ON A** or **REPEAT ON A**.

Note that the **DELAY A-B** setting appears on the display - below the **TRIGGER** setting, and that the trigger sense is shown next to the control circuit names on the graph.

If **SINGLE ON A** is selected, then you can view the status of the control circuits when a particular event occurs.

If **REPEAT ON A** is selected, then you can view the status of the control circuits each time a particular event occurs.

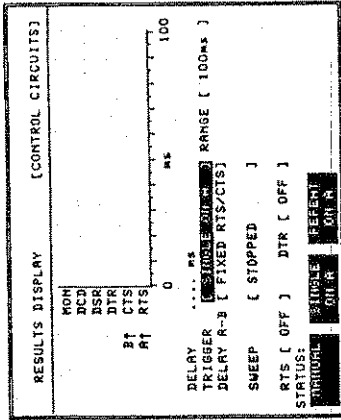

Highlight the RANGE setting, then select the period for which the instrument will sweep, once it has been triggered - either 100ms, 1s or 10s.

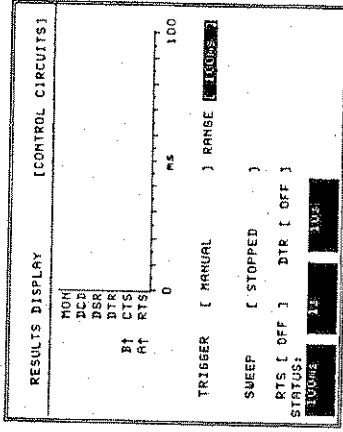

Highlight the SWEEP setting, then select RUN

RUNNING will be displayed for the period selected in the RANGE setting, then the status of all the control circuits will be displayed graphically.

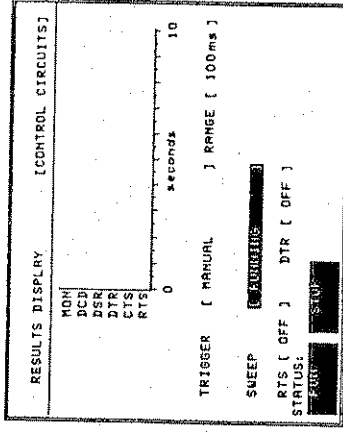

To View the Current State of All Control Circuits

If you are testing synchronous data:

Press **(RESULTS)** followed by **MORE**, then select **CONTROL CIRCUITS**.

or

If you are testing asynchronous data:

Press **(RESULTS)**, then select **CONTROL CIRCUITS**.

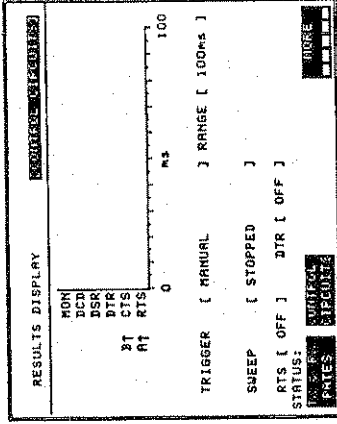

Highlight the **TRIGGER** setting, then select **MANUAL**.

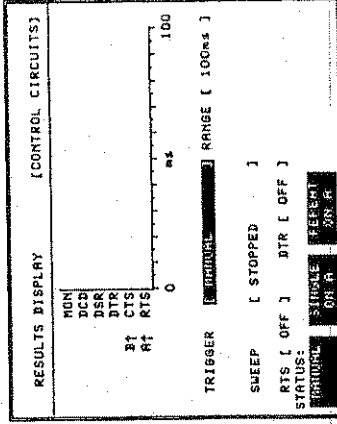



To Emulate a DTE or DCE

Press **(SETTINGS)**, then use the cursor key to highlight the terminal emulation setting (DTE or DCE).

APPLICATION	1	DATACOM)
INTERFACE	1	V.24)
CHARACTER LENGTH	[7]	STOP BITS	[1]
PARITY	[ODD])
TX DATA RATE (ASYNC)	[9600 b/s])
PATTERN	[2-20-1])
BLOCK LENGTH	[NORMAL])
ERROR CORR.	[AUTO])
STATUS:	[DTE])

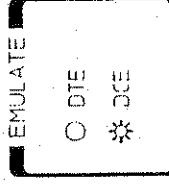
When the emulation setting is changed, the *EMULATE* indicators on the Datacom Module change state.



 - DENOTES LIT INDICATOR

For more details on emulation, see page 2-7.

To Select the Datacom Interface

Press **SETTINGS** to highlight the **INTERFACE** setting.

Listed below are the available settings:

RS-232

RS-449 TERMINATED

RS-449 UNTERMINATED

V.35

APPLICATION	[DATACOM]
INTERFACE	[RS-232] [ASYNC]
CHARACTER LENGTH	[7] STOP BITS [1]
PARITY	[ODD]
TX DATA RATE (ASYNC)	[9600 b/s]
PATTERN	[2-20-1]
BLOCK LENGTH	[NORMAL]
ERROR ADD	[AUTO]
	[SINGLE]
STATUS:	[V.35] [RS-232] [RS-449] [LEASED]

Only one interface is active at a time. For more details on datacom interfaces, see page 2-4.

Note



Control circuit timing is not available if you select **X.21 LEASED**.

Using and Checking Control Circuits

This chapter describes the tasks you may need to do to use and check control circuits. To access tasks quickly refer to the following list of datacom test issues for page references.

- Which datacom interface is to be used? page 5-2
- Is the Datacom Analyzer to emulate a DTE or DCE? page 5-3
- Do you want to view the current state of all the control circuits? page 5-4
- Do you want to measure RTS-CTS (RS-CS) delay? page 5-6
- Do you want to measure the delay between any two events? page 5-8

To Print Text Results from the Store

Having selected the test you want as shown in *To Select a Stored Test* on page 4-9:

Press **TEXT RESULTS** followed by **PRINT**.

```
HP7732A DATACOM SETTINGS
V.24 DTE SYNC
INTERNAL INTERFACE
TX CLOCK SOURCE
RX CLOCK SOURCE
TX DATA RATE 9600b/s
TX DATA POLARITY NORMAL
RX DATA POLARITY NORMAL
RX SYNC LOSS LOW THRESHOLD
PATTERN 2*20-1 (NORMAL)
BLOCK LENGTH AUTO
STATUS:
STORE:
RESULTS:
PRINT:
PREV:
PAGE:
NEXT:
PAGE:
```

To Print Graphic Results from the Store

Having selected the test you want as shown in *To Select a Stored Test* on page 4-9:

Press **GRAPH RESULTS**. Ensure the displayed graph-time base is set to what you want, see pages 3-5 to 3-7.

Press **MORE** followed by **PRINT**.

```
HP7732A DATACOM SETTINGS
V.24 DTE SYNC
INTERNAL INTERFACE
TX CLOCK SOURCE
RX CLOCK SOURCE
TX DATA RATE 9600b/s
TX DATA POLARITY NORMAL
RX DATA POLARITY NORMAL
RX SYNC LOSS LOW THRESHOLD
PATTERN 2*20-1 (NORMAL)
BLOCK LENGTH AUTO
STATUS:
STORE:
RESULTS:
PRINT:
PREV:
PAGE:
NEXT:
PAGE:
POWER
BLOCK
ERROR
COUNT
STATUS:
TIME
RESULTS:
PRINT:
PAGE:
NEXT:
PAGE:
```

To Print Stored Results

Note

A sampling resolution of 1 minute, 15 minutes or 1 hour must have been selected for results to be stored, see page 2-23.



Up to 10 sets of results can be stored (both datacom and telecom results can be held in the store), each set of results is date and time stamped.

Stored results can be printed as text or as graphs. To print stored results you must:

- Display the table of stored tests.
 - Select the test you want to print.
 - Select the result format - text or graphs.
- For graphs, the printout is identical to the graphs shown on the display. There are three graphs stored (only two can be displayed at a time), all three graphs are printed. To set the graph time base settings, see pages 3-5 to 3-7.

To Select a Stored Test

Press **(GRAPHS)** followed by **TEXT RESULTS** and **STORE STATUS**.

Use the cursor keys to select the test you want. The D and T in column one on the display denotes a datacom and telecom test respectively.

STORE NAME	START TIME	TEST DESCRIPTION	STORE USE
-9			
-7			
-6			
-5D	28-MAR-1989	10:15 00d 00h 01a	<IX
-4D	30-MAR-1989	06:37 00d 00h 01a	<IX
-3T	30-MAR-1989	06:37 00d 00h 01a	<IX
ENDC	30-MAR-1989	06:39 01d 03h 19a	80X
-1D	30-MAR-1989	06:39 00d 00h 01a	<IX
TEST	30-MAR-1989	07:08 00d 00h 01a	<IX
00d 06h 44m STORE FREE			USED 80%
AT CURRENT 1 MINUTE			TOTAL FREE 20%
SAMPLE PERIOD.			

STATUS: **TEST RESULTS** **DELETE** **DELETE ALL**

To Print Current Results and Settings (on demand)

The **(PRINT NOW)** key on the front panel of the HP37722A or HP 37732A enables the user to print a *snapshot of results and instrument settings* at any time during a test or after a test. If you print results during a test the measurement results are printed but may not be meaningful.

Press **(PRINT NOW)**.

To Print Current Results as Graphs

Note A sampling resolution of 1 minute, 15 minutes or 1 hour must be selected before you run your test, see page 2-23.



The current results can be printed as graphs at the end of the test. The graphs will be identical to those shown on the display. Three graphs are available for display (only two can be displayed at a time), all three are printed. To set the graph time base settings, see pages 3-5 to 3-7.

Press **(GRAPHS)**

Ensure the displayed graph time base is set to what you want, see pages 3-5 to 3-7.

Press **(MORE)** followed by **(PRINT)**.

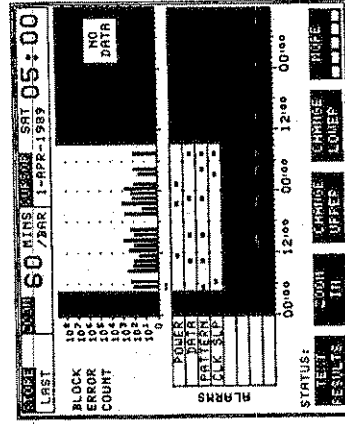

Highlight the PRINT STYLE setting, then select NORMAL for an 80-column printer or COMPRESS for a 40-column printer.

FUNCTION	[RS232 PORT]
RS232	[ALTERNATE PRINTER]
PRINT STYLE	[COMPRESS]
PROTOCOL	[DTR]
SPEED	[9600 BAUD]
PARITY	[NONE] (8-bit data)
STOP BITS	[1]
STATUS:	[0]
	[4500] [5000] [NONE]
	[8A0D] [8A0B] []

Highlight the SPEED setting, then select 9600.

FUNCTION	[RS232 PORT]
RS232	[ALTERNATE PRINTER]
PRINT STYLE	[COMPRESS]
PROTOCOL	[DTR]
SPEED	[9600]
PARITY	[NONE] (8-bit data)
STOP BITS	[1]
STATUS:	[0]
	[4500] [5000] [NONE]
	[8A0D] [8A0B] []

Highlight the STOP BITS setting, then select 1.

FUNCTION	[RS232 PORT]
RS232	[ALTERNATE PRINTER]
PRINT STYLE	[COMPRESS]
PROTOCOL	[DTR]
SPEED	[9600 BAUD]
PARITY	[NONE] (8-bit data)
STOP BITS	[1]
STATUS:	[0]
	[4500] [5000] [NONE]
	[8A0D] [8A0B] []

Using an Alternative (non Hewlett-Packard) Printer

This section shows you how to set up the baud rate, character format and pacing when using an alternative (non Hewlett-Packard) printer.

Press **OTHER** then select **RS232 PORT**.

FUNCTION	[RS232 PORT]
RS232	[H-P PRINTER]
PROTOCOL	[XON/XOFF]
SPEED	[9600 BAUD]
PARITY	[NONE] (8-bit data)
STOP BITS	[1]

STATUS: [MISCELLANEOUS] [RS232 PORT] [MORE]
[RETURN] [F1] [F2] [F3] [F4] [F5] [F6] [F7] [F8] [F9] [F10] [F11] [F12]

Highlight the RS232 setting, then select **ALT PRINTER**.

FUNCTION	[RS232 PORT]
RS232	[ALTERNATIVE PRINTER]
PRINT STYLE	[COMPRESS]
PROTOCOL	[BTR]
SPEED	[9600 BAUD]
PARITY	[NONE] (8-bit data)
STOP BITS	[1]

STATUS: [TERMINAL CONTROL] [H-P PRINTER] [ALT PRINTER] [MORE]
[RETURN] [F1] [F2] [F3] [F4] [F5] [F6] [F7] [F8] [F9] [F10] [F11] [F12]

Highlight the SPEED setting, then select 9600.

FUNCTION	[RS232 PORT]
RS232	[N-P PRINTER]
PROTOCOL	[XON/XOFF]
SPEED	[9600 BAUD]
PARITY	[NONE] (8-bit data)
STOP BITS	[1]
STATUS:	ERROR: NONE

Highlight the STOP BITS setting, then select 1.

FUNCTION	[RS232 PORT]
RS232	[N-P PRINTER]
PROTOCOL	[OFF]
SPEED	[9600 BAUD]
PARITY	[NONE] (8-bit data)
STOP BITS	[1]
STATUS:	

Press **OTHER**, then select **RS232 PORT**.

FUNCTION	[RS232 PORT]
RS232	[H-P PRINTER]
PROTOCOL	[XON/XOFF]
SPEED	[9600 BRUD]
PARITY	[NONE] (8-bit data)
STOP BITS	[1]

STATUS: OFF
COMPUTER CONTROL: OFF
H-P PRINTER: OFF
RS232 PORT: OFF

Highlight the **RS232** setting, then select **H-P PRINTER**.

FUNCTION	[RS232 PORT]
RS232	[H-P PRINTER]
PROTOCOL	[XON/XOFF]
SPEED	[9600 BRUD]
PARITY	[NONE] (8-bit data)
STOP BITS	[1]

STATUS: OFF
COMPUTER CONTROL: OFF
H-P PRINTER: OFF
RS232 PORT: OFF

Highlight the **PROTOCOL** setting, then select **XON/XOFF**.

FUNCTION	[RS232 PORT]
RS232	[H-P PRINTER]
PROTOCOL	[XON/XOFF]
SPEED	[9600 BRUD]
PARITY	[NONE] (8-bit data)
STOP BITS	[1]

STATUS: OFF
COMPUTER CONTROL: OFF
H-P PRINTER: OFF
RS232 PORT: OFF

Cable Connection - (DCE to DTE)

The accessory cable HP 15714A may be used to connect the printer to the RS-232 port (which is next to the ACCESSORY port on the side-panel) provided the printer connector is a 25-way subminiature D-Type, otherwise a suitable DCE to DTE cable connection will have to be made.

Using a Hewlett-Packard Printer - HP 2225D ThinkJet

This section shows you how to set up the baud rate, character format and pacing when using an HP 2225D ThinkJet 80-column printer. The HP 2225D ThinkJet is configured by the RS-232 switch settings on the rear of the printer. The printer switch settings are shown below:

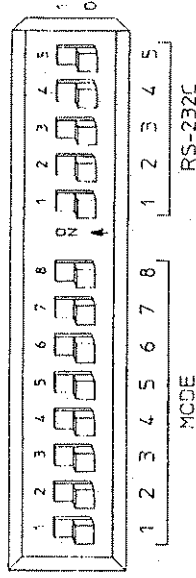

Printer Selection

The printer can be any 80-column printer (recommended type HP 2225D ThinkJet), or any 40-column printer with 80-column condensed format capability. Printers must also have a serial V.24/RS-232 interface.

To Select Baud Rate, Character Format and Pacing

The baud rate, character format and pacing of the printer being used must be compatible with the HP 37722A or HP 37732A:

Baud Rate	300, 600, 1200, 1800, 2400, 4800 or 9600
Data Bits	8
Parity	None
Stop Bits	1 or 2
Pacing	ENQ/ACK, Xon/Xoff or DTR*

* If an alternative (non Hewlett-Packard) printer is used then its pacing must be DTR.

Printing BER Results and Settings

This chapter contains the tasks you need to do to print results and instrument settings. To access tasks quickly refer to the following list of printing issues for page references.

- What printers are suitable? page 4-2
- What baud rates, character format and pacing can be used? page 4-2
- What cables do you need? page 4-3
- Do you want to use an HP ThinkJet printer? page 4-3
- Do you want to use a non-HP printer? page 4-6
- Do you want to print (on demand) current results and settings? page 4-8
- Do you want to print current results as graphs? page 4-8
- Do you want to print results stored in the instrument? page 4-9

A typical alarm seconds results display is shown here.

STORE	TIME	05:40	STOP	05:41
LAST	SAT	1-APR-1989	SAT	1-APR-1989
ALARM SECONDS				
POWER LOSS				
DATA LOSS				
PATTERN LOSS				
CLOCK LOSS				
0				
0				
2				
1				
ELAPSED TIME 00h 00m 00s 12s				
STATUS:				
STORE	GRAPH	FRUIT	PREV	NEXT
STATUS	RESULTS	PRICE	PRICE	PRICE

To View Stored Results as Text

Press **GRAPHS** followed by **TEXT RESULTS** and **STORE STATUS**, to access the store status table.

Use the cursor keys to select the test you want (in the left column on the display). Note the last (or bottom entry in the table) is the most recent test. D denotes a datacom test and T a telecom test.

STORE	START DATE	START TIME	TEST TIME	TEST USE	STORE USE
-9					
-8					
-7					
-6					
-5D	28-MAR-1989	10:15	00d 00h 01m	01h	<1%
-4T	30-MAR-1989	06:37	00d 00h 01m	01h	<1%
-3T	30-MAR-1989	06:37	00d 00h 01m	01h	<1%
DEMO	30-MAR-1989	06:38	01d 00h 17m	17h	80%
-1D	30-MAR-1989	06:39	00d 00h 01m	01h	<1%
DEMO	30-MAR-1989	07:08	00d 00h 01m	01h	<1%
00d 04h 44m STORE FREE				USED	80%
BT CURRENT 1 MINUTE				TOTAL FREE	20%
SAMPLE PERIOD:					

STATUS: **GRAPH** **TEXT** **DELETE** **DELETE**
RESULTS **RESULTS** **STORE** **ALL**

Press **TEXT RESULTS**.

Use **NEXT PAGE** and **PREV PAGE** to access results and instrument settings.

A typical main instrument setting display is shown here.

STORE	START DATE	START TIME	TEST TIME	TEST USE	STORE USE
LAST	SAT 1-APR-1989	05:24	010p	SRT	1-APR-1989
MP37732A DATACOM SETTINGS					
INTERFACE V.24 DTE SYNC					
TX CLOCK SOURCE INTERNAL					
RX CLOCK SOURCE INTERFACE					
TX DATA RATE 9600b74					
TX DATA POLARITY NORMAL					
RX DATA POLARITY NORMAL					
RX SYNC LOSS LOW THRESHOLD					
PATTERN 2*20-1 (NORMAL)					
CLOCK LENGTH AUTO					
STATUS: GRAPH TEXT DELETE DELETE RESULTS RESULTS STORE ALL					

A typical error results display is shown here.

STORE	START DATE	START TIME	TEST TIME	TEST USE	STORE USE
LAST	SAT 1-APR-1989	05:24	010p	SRT	1-APR-1989
BIT ERROR RESULTS					
BIT ERRORS		12	BIT ER	1.0E-04	
ERROR SECS		12	ZEFS	0.00%	
BIT ERROR ANALYSIS					
UNAVAIL SECS		0	XAVAIL	100.00%	
ERRORED SECS		12		100.00%	
SEV ERR SECS		0		0.00%	
DES. MINS		1		100.00%	
BLOCK ERROR RESULTS					
BLK ERRORS		1	BLK ER	1.0E+00	
BLK COUNT		1			
CLOCK SLIPS		0			
STATUS: GRAPH TEXT DELETE DELETE RESULTS RESULTS STORE ALL					
ELAPSED TIME 00d 00h 00m 12s					

To View Stored Results as Graphs

Press **GRAPHS** followed by **TEXT RESULTS** and **STORE STATUS** to access the store status table.

Use the cursor keys to select the test you want (in the left column on the display). Note the last (or bottom entry in the table) is the most recent test. D denotes a datacom test and T a telecom test.

To select EFS or %EFS press **OTHER** and select **MISCELLANEOUS**.

Press **GRAPH RESULTS**.

How you view these results is describe in *To View Results as Graphs*, see page 3-5.

STORE	STATUS	DATE	TIME	TEST	DESCRIPTION	STORE	USE
-9							
-8							
-7							
-6							
-5D		28-MAR-1989	10:15	00d 00h 01m			K1Z
-4D		30-MAR-1989	06:37	00d 00h 01m			K1Z
-3T		30-MAR-1989	06:37	00d 00h 01m			K1Z
DEMO		30-MAR-1989	06:38	01d 03h 19m			80Z
-1D		30-MAR-1989	06:39	00d 00h 01m			K1Z
TEST		30-MAR-1989	07:08	00d 00h 01m			K1Z
		00d 06h 44m STORE FREE		TOTAL	USED	90Z	
		AT CURRENT 1 MINUTE		TOTAL	FREE	20Z	
		SAMPLE PERIOD:					
STATUS:							
GRAPH		TEXT		DELETE		DELETE	
RESULTS		RESULTS		STORE		ALL	

To View Current Results as Graphs

If you want to view current results as a graph while you are running a test or at the end of a test, then the sampling resolution must be set to either 1 minute, 15 minutes or 1 hour before you run the test.

When a sampling resolution is selected and you run a test, results are logged into the instrument results store. Note, if results are already in the store, the oldest will be overwritten if there is not enough space to store your current test. Before you run your test see how much free space is available, see page 2-23. It may be necessary to delete unwanted tests.

Press **GRAPHS**.

How you view these results is describe in
To View Results as Graphs, see page 3-5.

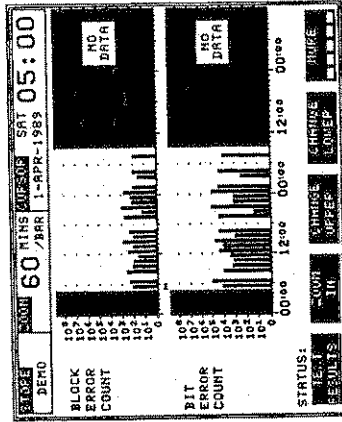

To View Measurement Results in Detail

Use the cursor keys to move the cursor on the display to the time of interest (the CURSOR start time and date is shown in the top right box on the display).

Use the ZOOM function to select either 15 MINS/BAR or 1 MINS/BAR.

A typical display at 15 MINS/BAR is shown here.

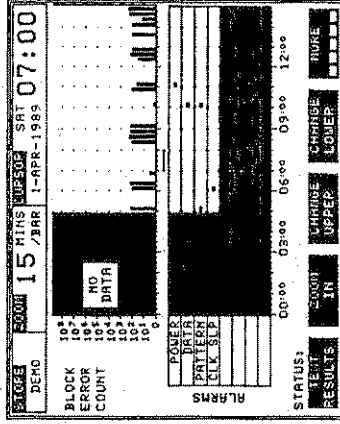

A typical display at 1 MINS/BAR is shown here.

You can view results that are not currently on the display as follows:

Move the cursor to either right or left end of the display as appropriate.

Press the cursor key once more to display the next set of results.

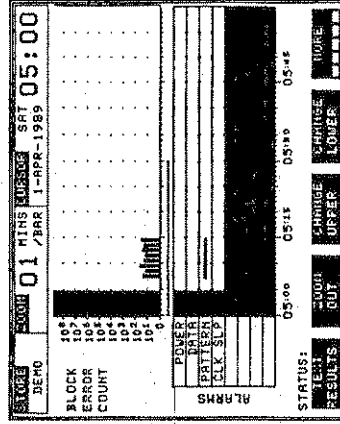

To view the third graph, use either **CHANGE UPPER** or **CHANGE LOWER**.

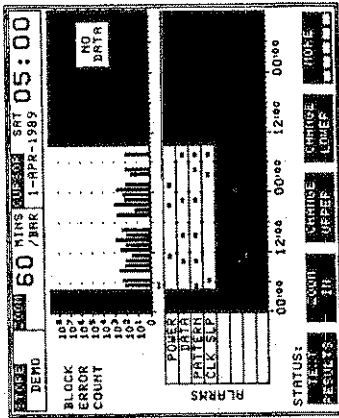

To View All Error and Alarm Results

If the **ZOOM** setting (in the middle box at the top of the display) is **60 MINS/BAR**, then all error and alarm results may be seen.

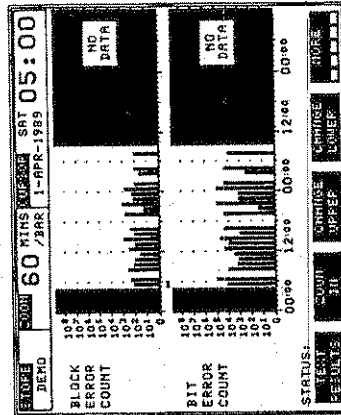

If the setting is not **60 MINS/BAR**, then use the **ZOOM** function.

The **ZOOM** function is a repeating fixed sequence:

- **60 MINS/BAR**, **15 MINS/BAR** then **1 MIN/BAR** if a 1 minute sampling resolution has been selected.
- **60 MINS/BAR** then **15 MINS/BAR** if a 15 minute sampling resolution has been selected.
- **60 MINS/BAR** only if a 60 minute sampling resolution has been selected.

You may now want to look in more detail at a specific part of the results.

To View Results as Graphs

Graphs make it easy to see how errors and alarms relate to each other, and to time. Knowing when and how often errors occur can help you pinpoint their cause.

You can display:

- Up to 1 day 8 hours, 20 days or 80 days of results depending on the sampling resolution selected - see page 2-23.

- A specific part of a measurement in detail by zooming-in to a specific time.

Three graphs are available for display, but only two can be shown at a time.

The graphs available are:

- Bit Errors
- Block Errors
- Alarms

A graph of results can only be displayed if a sampling resolution of 1 minute, 15 minutes or 1 hour is selected before you run your test, see page 2-23.

Press **GRAPHS**.

There will be two graphs displayed.

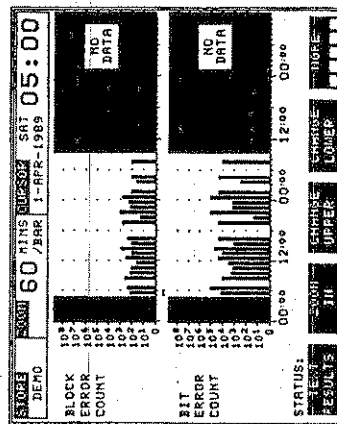

To View TX & RX Rates (Synchronous Data Only)

The instrument must be set for synchronous data.

Press **RESULTS** followed by **MORE**, then select **TX & RX RATES**.

A typical TX/RX frequency display is as shown.

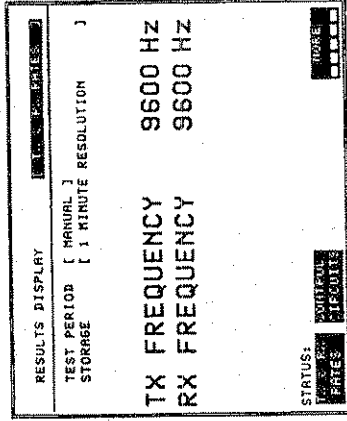

To View Alarm Seconds

Press **(RESULTS)**, then select **ALARM SECONDS**.

A typical set of displayed alarms is as shown.

For more details on Alarms, see *Appendix D*.

RESULTS DISPLAY		G.821 ALARM SECONDS	
TEST PERIOD	[MANUAL]		
STORAGE	[1 MINUTE RESOLUTION]		
DATA LOSS			6
PATTERN LOSS			6
CLOCK LOSS			2
POWER LOSS			0
ELAPSED TIME 00d 00h 00m 13s			
STATUS: ALL ALARM RESULTS CIRCLED			

To View G.821 Analysis Results (Synchronous Data Only)

The instrument must be set for synchronous data and the measurement TEST PERIOD must be set to **MANUAL** or **SINGLE**.

Press **(RESULTS)**, then select

G.281 ANALYSIS.

A typical set of displayed results is as shown.

For more details on G.821 Analysis, see *Appendix C*.

RESULTS DISPLAY		G.821 ANALYSIS	
TEST PERIOD	[MANUAL]		
AVAILABILITY UNAVAILABLE SECONDS		0	100.00%
ERRORED SECONDS		19	95.00%
SEVERELY ERRORED SECS		0	0.00%
DEGRADED MINUTES		1	100.00%
ELAPSED TIME 00d 00h 00m 20s			
STATUS: ALL G.821 ANALYSIS RESULTS CIRCLED			

To View Bit Error Results

Press **RESULTS**.

If **BASIC RESULTS** is selected, a typical set of displayed results is as shown.

RESULTS DISPLAY		[BASIC RESULTS]	
TEST PERIOD	[MANUAL]		
STORAGE	[1 MINUTE RESOLUTION]		
BIT ERRORS	10		
%EFS	35.71%		
ES	9		
AVERAGE ER	9.6E-05		
STATUS:		ELAPSED TIME	000 000 145
RESULTS	ALL RESULTS	CONTROL	RESULTS

To select **EFS** or **%EFS** before, during or after a test.

Press **OTHER**.

Select **MISCELLANEOUS**.

FUNCTION		[MISCELLANEOUS]	
KEYBOARD LOCK	[I OFF]		
BEEP ON ERROR	[I OFF]		
DESELECTED TIMESLOTS	[2-6-1]		
DISPLAY EFS OR KEYS	[%EFS]		
STATUS:		EFS	%EFS

If **ALL RESULTS** is selected, a typical set of displayed results is as shown.

For more details on bit error results, see *Appendix B*.

RESULTS DISPLAY		[ALL RESULTS]	
TEST PERIOD	[MANUAL]		
STORAGE	[1 MINUTE RESOLUTION]		
BIT ERROR COUNT	10		
PERCENT ERROR	35.71%		
ERROR FREE SECONDS	0		
BLOCK ERROR COUNT	0		
BIT ERROR RATIO	9.6E-05		
BLOCK ERROR RATIO	0		
CLOCK SLIPS	0		
STATUS:		ELAPSED TIME	000 000 145
RESULTS	ALL RESULTS	CONTROL	RESULTS

Viewing BER Results

This chapter describes the tasks you may need to do to view datacom BER results. To access tasks quickly refer to the following list of datacom BER results issues for page references.

- Do you want to view current bit error results? page 3-2
- Do you want to view current alarm seconds? page 3-3
- Do you want to view G.821 Analysis (synchronous data only)? page 3-3
- Do you want to view current TX and RX rates (synchronous data only)? page 3-4
- Do you want to view results as graphs? page 3-5
- Do you want to view current results as graphs? page 3-8
- Do you want to view stored results as graphs? page 3-9
- Do you want to view stored results as text? page 3-10

To add a label next to the **SETTING** number:

Highlight the **LOCK** setting, then select **OFF**.

Move the cursor next to the number that you want labeled.

The label can be made up from the alphabet *A* to *Z*, a *space character* and numbers *0* to *9*.

The **JUMP** key allows you to alternate between *letters* and *numbers*.

The **NEXT CHARACTER** and **PREVIOUS CHARACTER** keys allows you to select the character you want.

The arrow keys at the bottom of the display allows you to move between characters in the label.

Highlight the **ACTION** setting, then select **SAVE**. Note that the **LOCK** setting automatically changes to **ON**.

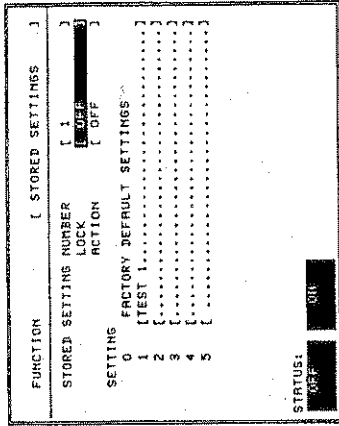

To Run a measurement

Press **(START STOP)**, the green indicator lights to show that the measurement is running.

Pressing **(START STOP)** again will stop the measurement if it has not already stopped.

To check the free space in the store:

Press **GRAPHS** followed by **TEXT RESULTS** and **STORE STATUS**.

The **TOTAL FREE** space is shown as a percentage of the total capacity of the store at the bottom right of the display.

To delete results from the store:

Use the cursor keys to highlight the test you want to delete (in the left column on the display), then press **DELETE STORE**.

Note the last (or bottom entry in the table) is the most recent test. D denotes a datacom test and a T denotes a telecom test.

STORE	DATE	TIME	TEST	STORE	FREE
-9					
-8					
-4					
-SD	20-MAR-1989	10:15	00d 00h 01a	<1Z	
-4D	30-MAR-1989	06:37	00d 00h 01a	<1Z	
-ST	30-MAR-1989	06:37	00d 00h 01a	<1Z	
DEND	30-MAR-1989	06:38	01d 03h 19a	80Z	
-1D	30-MAR-1989	06:39	00d 00h 01a	<1Z	
-33Z	30-MAR-1989	07:09	00d 00h 01a	<1Z	
00d 06h 44a STORE FREE				TOTAL USED	80Z
AT CURRENT 1 MINUTE				TOTAL FREE	20Z
SAMPLE PERIOD.					

STATUS: **DELETE RESULTS** **DELETE STORE** **DELETE ALL**

To Store Instrument Settings

Having set up the instrument, use the following to store the settings:

Press **OTHER** followed by **STORE SETTINGS**.

Highlight the **STORED SETTING NUMBER**, then select the number that you want settings to be stored under - from 1 to

5.

FUNCTION	[STORED SETTINGS]
STORED SETTING NUMBER	[1]
LOCK	[ON]
ACTION	[OFF]
SETTING	
0	FACTORY DEFAULT SETTINGS
1
2
3
4
5

STATUS: **0** **1** **2** **3** **4** **5** **STORE**

To Store Results

Press **(RESULTS)**, highlight the **STORAGE** setting then select the sampling resolution you want - **1 MIN RESOL'N**,

15 MIN RESOL'N or **1 HOUR RESOL'N**.

The resolution affects the instrument storage capacity as follows:

- A 1 minute sampling resolution gives up to 1 day 8 hours of results.
- A 15 minute sampling resolution gives up to 20 days of results.
- A 1 hour sampling resolution gives up to 80 days of results.

Up to ten sets of results can be stored, the tests can have different resolutions. When the store becomes full the oldest results are overwritten by the new.

Stored results can be displayed later as text or as graphs or they can be printed.

RESULTS DISPLAY	[1]	BASIC RESULTS	[3]
TEST PERIOD	[BIT]	LENGTH	[1E4]
STORAGE	[15 MIN]	RESOLUTION	[15 MIN]
BIT ERRORS			
%EFS			
AVERAGE ER			
ELAPSED BITS			
STATUS:	[OFF]	[15 MIN]	[1 HOUR]
	[RESOL'N]	[RESOL'N]	[RESOL'N]

To Check Store Status and Delete Results from the Store

If you want to store a new test or want to view results graphically as you run your test, then check the free space in the store. If there is not enough space to store your new test then delete unwanted results, otherwise results will be overwritten (you may lose results that you wanted to keep).

Highlight the RANGE setting, then select the period for which the instrument will sweep once it has been triggered, either 100ms, 1s or 10s.

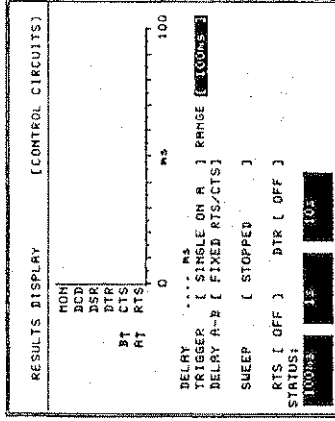

Highlight the DELAY A-B setting, then select USER PROGRAM.

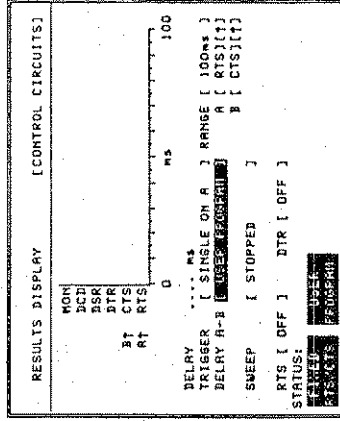

Highlight the A setting, then select the first control circuit you want to monitor events on - RT, CTS, DTR, DSR, DCD or MON (for V.24 interface). Then select the trigger sense (rising edge or falling edge).

Highlight the B setting, then select the second control circuit you want to monitor events on - RT, CTS, DTR, DSR, DCD or MON (for V.24 interface).

Then select the trigger sense (rising edge or falling edge).

Highlight the SWEEP setting, then select RUN.

RUNNING will be displayed until event A occurs, then for the period selected in the RANGE setting.

The delay will then be displayed both graphically and as a measured value.

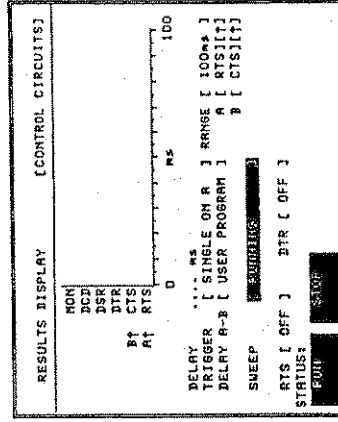
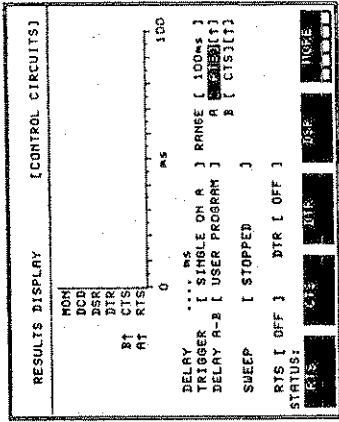

General Information

Introduction

This manual contains information which allows the user to operate and calibrate the datacom part of the HP 37732A Telecom/Datacom Analyzer or the HP 15901A Option 001 Datacom Module when fitted to the HP 37722A Digital Telecom Analyzer.

On the title page of this manual is a Microfiche Part Number. This number can be used to order 4 X 6 inch microfilm transparencies of the manual.

Each microfiche contains up to 96 photo duplicates of the manual pages.

Specification

Instrument specifications are listed on page 6-5. These specifications are the performance standards or limits against which the datacom part of the HP 37732A and HP 15901A Option 001 (when fitted to the HP 37722A) are tested.

The telecom specifications for the HP 37732A are contained in the HP 37722A Digital Telecom Analyzer manual.

Safety Considerations

This product is a Safety Class I instrument (provided with a protective earth terminal). The instrument and manual should be reviewed for safety markings and instructions before operation. Also read the Warning page at the front of this manual.

Instruments Covered by Manual

If you have a HP 37732A Telecom/Datacom Analyzer then there is only one serial number. If you have a HP 15901A Option 001 Datacom Module fitted to a HP 37722A Digital Telecom Analyzer then there are serial numbers on both the Datacom Module and the Digital Telecom Analyzer. A general description of serial numbers is contained in the following paragraphs.

Attached to the instrument is a serial number plate. This serial number is in the form XXXXUXXXXX. It is in two parts; the first four digits and the letter are the serial prefix and the last five are the suffix. The prefix is the same for all identical instruments, it changes only when a change is made to the instrument. The suffix however, is assigned sequentially and is different for each instrument. The contents of this manual apply to instruments with the serial number prefix(es) listed under SERIAL NUMBERS on the title page.

An instrument manufactured after the printing of this manual may have a number prefix that is not listed on the title page. The unlisted serial number prefix indicates the instrument is different from those described in this manual. The manual for this new instrument is accompanied by a Manual Changes supplement. This supplement contains "change information" that explains how to adapt the manual to the new instrument.

In addition to change information, the supplement may contain information for correcting errors in the manual. To keep this manual as current and accurate as possible, Hewlett-Packard recommends that you periodically request the latest Manual Changes supplement. The supplement for this manual is identified with the manual print date and part number, both of which appear on the manual title page. Complementary copies of the supplement are available from Hewlett-Packard. For information concerning a serial number

prefix that is not listed on the manual title page or in the Manual Changes supplement, contact your nearest Hewlett-Packard office.

Options Available

The options which may have been ordered with the HP 37732A Telecom/Datacom Analyzer are as follows:

- Option 002 Unframed pattern generation and measurements at 8 Mbit/s.
- Option 003 Framed/unframed pattern generation and measurements at 704 kbit/s.
- Option 004 Replaces four BNC connectors on the unbalanced ports with small Siemens connectors.
- Option 005 Sub rate testing, timeslot access, tone generation and measurement.
- Option 006 Timeslot access, tone generation and measurement.
- Option 908 Rack mount kit.
- Option B12 Battery Power Source (rechargeable).
- Option H08 Bit error counting suppressed during pattern sync loss.
- Option V01 Virtual remote operation (needs HP 15800A virtual remote software).
- Option X58 X.58 testing.

To check which options are fitted - Press the **OTHER** key on the front panel then select **OPTIONS**.

Accessories Supplied

The accessories that are supplied with the HP 37732A Telecom/Datacom Analyzer and the HP 15901A Option 001 Datacom Module are as follows:

<i>Accessories Supplied</i>	<i>Part Number</i>
Power Cord *	See Installation Chapter
Operating and Calibration Manual	HP 15901-90009
V.24 Patch Wires (6 off)	HP 15901-60003
V.11 to X.21 Adapter	HP 15901 -60005

* Only supplied with the HP 37732A.

Accessories Available

The following accessories are available and may have been ordered with the Telecom/Datacom Analyzer:

HP 15510A	Protective monitor probe with BNC connectors for 75 Ω unbalanced systems.
HP 15511A	Protective monitor probe with 3-pin Siemens connectors for 120 Ω balanced systems.
HP 15512A	1 m (3 ft) test cable with two 3-pin Siemens male connectors.
HP 15525A	1.3 m (4 ft) coaxial test cable with two BNC unbalanced 75 Ω connectors.
HP 15525A Opt 003	1.3 m (4 ft) coaxial test cable with two small Siemens unbalanced 75 Ω connectors.
HP 15713A	19-inch rack mount kit - not suitable for instruments fitted with Battery Option B12.
HP 15716A	19-inch rack mount kit - suitable for instruments fitted with Battery Option B12.

HP 92204S	25-way V.24 Cable, 25-pin female D-type - 25-pin male D-type, length 1.2 m (4 feet).
HP 15692A	37-way V.11 Cable, 37-pin male - 37-pin male, length 3 m (10 feet).
HP 15708A	V.35 Cable, with male connectors at each end, length 3 m (10 feet).
HP 15710A	Carrying Case.
HP 2225D	Printer, ThinkJet RS-232.
HP 15714A	Cable, Telecom/Datacom Analyzer - HP 2225D Printer.
HP 5060-4462	RS-232 Test plug (for connector on side panel).
The following accessories are available and may have been ordered with the HP 15901A Option 001 Datacom Module:	
HP 15712A	19-inch rack mount kit - used in conjunction with rack mount kits for the HP 37722A.
HP 92204S	25-way V.24 Cable, 25-pin female D-type - 25-pin male D-type, length 1.2 m (4 feet).
HP 15692A	37-way V.11 Cable, 37-pin male - 37-pin male, length 3 m (10 feet).
HP 15708A	V.35 Cable, with male connectors at each end, length 3 m (10 feet).

Specification

This section contains the specification for the datacom part of the HP 37732A Telecom/Datacom Analyzer and the HP 15901A Option 001 Datacom Module (when fitted to the HP 37722A).

The telecom specifications for the HP 37732A are contained in the HP 37722A Digital Telecom Analyzer manual.

Except where otherwise stated the following parameters are *typical* or *nominal*. They provide a useful indication of the typical, but non-warranted, performance characteristics.

DATAKOM INTERFACES

The four datacom interfaces are provided via three connectors on the Datacom Module's front panel. Only one interface is active at any time. The active interface connector is indicated by an adjacent LED.

V.24

General Equivalent to RS-232/V.28
25 pin D-subminiature connector via Breakout.
Maximum data rate 128 kbit/s.

Drivers Output voltage (into 3 k Ω to 7 k Ω)
-12 V to -5 V: Binary 1 / Mark / OFF
+5 V to +12 V: Binary 0 / Space / ON
Slew rate 30 V/ μ s maximum.
Short circuit current less than 50 mA.

Receivers Input voltage:
0 V max: Binary 1 / Mark / OFF
+2 V min: Binary 0 / Space / ON
Maximum input voltage ± 18 V.
Input impedance 3 k Ω to 7 k Ω in parallel with four-state indicators.

Pin Assignments per ISO 2110-1980 (EIA-232-D)

The following interface circuits are implemented:

Pin	Circuit Name	V.24
1	Shield*	
2	Transmitted Data	TD 103
3	Received Data	RD 104
4	Request to Send	RTS 105
5	Clear to Send	CTS 106
6	Data Set Ready	DSR 107
7	Signal Ground	102
8	Data Carrier Detect	DCD 109
15	Transmit Clock (DCE Source)	TC 114
17	Receive Clock	RC 115
20	Data Terminal Ready	DTR 108
24	Transmit Clock (DTE Source)	XTC 113

* Connected to chassis. May be connected internally to signal ground.
 All other pins are unconnected.

V.11

General

Equivalent to RS-449
37 pin D-subminiature connector.
All ten balanced circuits are implemented and conform electrically to V.11 (RS-422-A, X.27).

Signal polarity:

A -ve wrt B: Binary 1 / Mark / OFF
A +ve wrt B: Binary 0 / Space / ON
Terminated or unterminated operation.

Drivers

Differential output voltage:

2 V minimum into 100 Ω
6 V maximum open circuit
Rise time 80 ns typical.
Short circuit current less than 180 mA.

Receivers

Differential input threshold voltage ± 0.2 V.

Input impedance:

Terminated: 100 Ω
Unterminated: 10 k Ω

Pin Assignments

Pin assignments per ISO 4902-1980 (RS-449).

The following interface circuits are implemented:

Pin	Circuit Name	V.24
1	Shield*	
4	Send Data (A)	SD 103
5	Send Timing (A)	ST 114
6	Receive Data (A)	RD 104
7	Request to Send (A)	RS 105
8	Receive Timing (A)	RT 115
9	Clear to Send (A)	CS 106
11	Data Mode (A)	DM 107
12	Terminal Ready (A)	TR 108
13	Receiver Ready (A)	RR 109
17	Terminal Timing (A)	TT 113
19	Signal Ground	SG 102
22	Send Data (B)	SD 103
23	Send Timing (B)	ST 114
24	Receive Data (B)	RD 104
25	Request to Send (B)	RS 105
26	Receive Timing (B)	RT 115
27	Clear to Send (B)	CS 106
29	Data Mode (B)	DM 107
30	Terminal Ready (B)	TR 108
31	Receiver Ready (B)	RR 109
35	Terminal Timing (B)	TT 113

* Connected to chassis. May be connected internally to signal ground.
All other pins are unconnected.

X.21 Leased

General

Leased (point-to-point) operation as specified by X.21. 15-pin D-subminiature connector via adapter block plugged into the V.11 interface.

All X.21 circuits are implemented, with the exception of byte timing (circuit B), and conform electrically to X.27 (V.11, RS-422-A).

Pin assignments per ISO 4903-1980.

Pin Assignment

The following interface circuits are implemented:

Pin	Circuit Name	
1	Shield*	
2	Transmit (A)	T
3	Control (A)	C
4	Receive (A)	R
5	Indication (A)	I
6	Signal Element Timing (A)	S
8	Signal Ground	G
9	Transmit (B)	T
10	Control (B)	C
11	Receive (B)	R
12	Indication (B)	I
13	Signal Element Timing (B)	S

* Connected to chassis. May be connected internally to signal ground. All other pins are unconnected.

V.35

General

34 pin rectangular connector.
Data and clock circuits are balanced according to V.35.
Balanced signal polarity:
A -ve wrt B: Binary 1 (OFF)
A +ve wrt B: Binary 0 (ON)
Control circuits are unbalanced according to V.28.

V.35 Drivers

Terminal-to-terminal voltage 0.66 V.
Source impedance $100 \Omega \pm 10\%$.
Resistance between shorted terminals and ground $150 \Omega \pm 10\%$.
Rise time less than 40 ns.
DC signal offset less than +0.6 V.

V.35 Receivers

Input impedance $100 \Omega \pm 10\%$.
Resistance between shorted terminals and ground $150 \Omega \pm 10\%$.

V.28 Drivers

Output voltage (into $3 \text{ k}\Omega$ to $7 \text{ k}\Omega$)
-12 V to -5 V: Binary 1 / Mark / OFF
+5 V to +12 V: Binary 0 / Space / ON
Slew rate $30 \text{ V}/\mu\text{s}$ maximum.
Short circuit current less than 50 mA.

V.28 Receivers

Input voltage
0 V max: Binary 1 / Mark / OFF
+2 V min: Binary 0 / Space / ON
Maximum input voltage $\pm 18 \text{ V}$.
Input impedance $3 \text{ k}\Omega$ to $7 \text{ k}\Omega$.

Pin Assignments

Pin assignments per ISO 2593-1984.

The following interface circuits are implemented:

Pin	Circuit Name	V.24
A	Shield*	
B	Signal Ground	102
C	Request to Send	RS 105
D	Clear to Send	CS 106
E	Data Set Ready	DSR 107
F	Receive Line Signal Detector	RLSD 109
H	Data Terminal Ready	DTR 108
P	Send Data (A)	SD 103
R	Receive Data (A)	RD 104
S	Send Data (B)	SD 103
T	Receive Data (B)	RD 104
U	Serial Clock Transmit External (A)	SCTE 113
V	Serial Clock Receive (A)	SCR 115
W	Serial Clock Transmit External (B)	SCTE 113
X	Serial Clock Receive (B)	SCR 115
Y	Serial Clock Transmit (A)	SCT 114
AA	Serial Clock Transmit (B)	SCT 114

* Connected to chassis. May be connected internally to signal ground.
All other pins are unconnected.

V.24 Breakout

Breakout Switches	On all data, clock and control circuits.
Four-state Indicators	On all data, clock and control circuits. Line-powered (less than 3 mA). Connected between the interface connector and breakout switches. Operation: Red: positive interface voltage Green: negative interface voltage Red and Green: activity None: no valid voltage present
Monitor Point	Has its own four-state indicator. Appears in control circuit timing.
Patch Points	On all 25 interface connector pins. On all data, clock and control circuits between drivers or receivers and breakout switches. 6 patch wires are provided.
Voltage Sources	Positive and negative interface voltage sources.

V.11/V.35/X.21 Leased Activity Indicators

General

Yellow LEDs.
Data and clock indicators flash when there is activity on the circuit.
For X.21 Leased operation, only 5 indicators are active, allocated as follows:

X.21	Indicator	
T	SD	SD 103
R	RD	RD 104
S	ST	SCT 114
C	RS	RS 105
I	CS	CS 106

Data Circuits

Indicator operation
On: Binary 1 / Mark
Off: Binary 0 / Space

Clock and Control Circuits

Indicator operation:
On: ON
Off: OFF

TERMINAL EMULATION

The Datacom Module may be configured as DTE or DCE, indicated by two status indicators on its front panel.

DTE Mode

Data and Clock Circuits:

Connected to the Analyzer Transmitter and Receiver as follows:

37732A Signal	V.24	V.11	X.21	V.35
Transmitter Data Out	TD	SD	T	SD
Receiver Data In	RD	RD	R	RD
Transmitter Clock Out	XTC	TT	-	SCTE
Transmitter Clock In	TC	ST	S	SCT
Receiver Clock In	RC	RT	S	SCR

Control Circuits:

Outputs and inputs as follows:

	V.24	V.11	X.21	V.35
Outputs	RTS	RS	C	RS
	DTR	TR	-	DTR
Inputs	CTS	CS	I	CS
	DSR	DM	-	DSR
	DCD	RR	-	RLSD

Outputs may be turned ON or OFF by the user (Control Circuits RESULTS page).

DCE Mode

Data and Clock Circuits

Connected to the Analyzers Transmitter and Receiver as follows:

37732A Signal	V.24	V.11	X.21	V.35
Transmitter Data Out	RD	RD	R	RD
Receiver Data In	TD	SD	T	SD
Transmitter Clock Out	RC	RT	S	SCR
Transmitter Clock In	TC	ST	-	SCT
Receiver Clock In	XTC	TT	-	SCTE
Receiver Clock In	XTC	TT	-	SCTE

Control Circuits

Outputs and inputs as follows:

	V.24	V.11	X.21	V.35
Outputs	CTS	CS	I	CS
	DSR	DM	-	DSR
	DCD	RR	-	RLSD
Inputs	RTS	RS	C	RS
	DTR	TR	-	DTR

Outputs may be turned ON or OFF by the user (Control Circuits RESULTS page).

TRANSMITTER

Synchronous Mode

Clock Sources

Internal synthesizer.
Datacom interface. May be inverted, allowing selectable clock/data phase relationship.
X.21 Leased operation limited as follows:
DTE datacom interface
DCE internal interface

Synthesizer Rates

Preset rates: 1.2, 2.4, 4.8, 9.6, 14.4, 19.2, 48, 56, 64, 256, 384, 512 kbit/s; 1.024, 1.984 Mbit/s.
User defined rate from 600 bit/s to 2.048 Mbit/s.
Resolution as follows:
 $< 10 \text{ kbit/s}$: 10 bit/s
 $\geq 10 \text{ kbit/s}, < 100 \text{ kbit/s}$: 100 bit/s
 $\geq 100 \text{ kbit/s}$: 1 kbit/s
Preset and user defined rates are limited to 128 kbit/s maximum in V.24 mode.

Synthesizer Accuracy (warranted)

Preset rates $\pm 10 \text{ ppm}$.
User defined rate $\pm 0.01\%$.
Ageing $\pm 2 \text{ ppm}$ per year typical.

Interface Clock Source

Minimum rate 50 bit/s.
Maximum rate 2.048 Mbit/s.

Clock Output

Datacom interface. May be inverted, allowing selectable clock/data phase relationship.
No clock output on X.21 Leased interface when configured as DTE.

Asynchronous Mode

General	Not provided for X.21 Leased operation.
Rates	Preset rates: 50, 75, 110, 134.5, 150, 200, 300, 600 bit/s, 1.2, 1.8, 2.4, 4.8, 7.2, 9.6, 19.2 kbit/s.
Character Format	Character length: 5, 6, 7 or 8 bits. Parity: odd, even, 0, 1 or none. Stop bits: 1 or 2 (character length 6, 7 or 8 bits); 1.5 (character length 5 bits).

Transmitter Facilities

Data Polarity	Normal or inverse polarity may be selected.
---------------	---

Error Add

Type	Bit error only.
Mode	Single error insert using key on Telecom Analyzer's front panel. Error add rate 1E-n, n=2 to 5.
Error Add Criteria	Only data bits are errored. Framing bits in asynchronous mode are not errored.

RECEIVER

Synchronous Mode

Rates Maximum rate 2.048 Mbit/s.

Clock Sources Datacom interface.
Internal (DCE mode only). Data is clocked coincident with
the transmitter output clock.
Both sources may be inverted, allowing selectable
clock/data phase relationship.
X.21 Leased operation limited as follows:
DTE datacom interface
DCE internal interface

Asynchronous Mode

General Not provided for X.21 operation.

Rates As selected for the transmitter.

Character Format As selected for the transmitter.

Significant Bits Only data bits are used when calculating Bit test periods
or BER measurements.

Receiver Facilities

Data Polarity Normal or inverse polarity may be selected.

Pattern Sync

Sync Loss

Caused by data loss alarm.
Caused by pressing MANUAL RESYNC key on Datacom Module's front panel.

Occurs automatically if the error ratio exceeds a user-selectable threshold as follows:

Low: Error ratio ≥ 0.1 in ≥ 1000 bits

Medium: Error ratio ≥ 0.25 in ≥ 1000 bits

High: Error ratio ≥ 0.25 in $\geq 100\ 000$ bits

Automatic sync loss may be declared over fewer bits if the number of errors counted would be sufficient to exceed the threshold ratio over the full 1000 or 100 000 bits.

Automatic sync loss can be disabled.

Sync loss is also caused by changing the pattern.

Sync Gain

Sync is regained after 31 consecutive error-free bits.
Pattern sync is indicated by a green *SIGNAL PRESENT* LED on the Telecom Analyzer's front panel.

Resync

Resync is attempted automatically upon sync loss.

Receiver Alarms

Data Loss

Loss of valid data for a second or more, defined as follows:
Sync mode: No clocks received
Async mode: No characters received
Red alarm LED on Datacom Module's front panel.

Pattern Sync Loss

See *Pattern Sync* paragraph on previous page.
Red alarm LED on Datacom Module's front panel.

Errors

Bit errors detected in received data.
Red alarm LED on Datacom Module's front panel.

Clock Slips

One or more bits have been added to or deleted from the received pattern.
Only valid for PRBS patterns.
Red alarm LED on Datacom Module's front panel.

Power Loss

Analyzers power supply interrupted during a BER measurement period.
No alarm LED.

Beep on Error

Operation

Beep on error can be enabled.
Beeper volume adjustable using keys on Telecom Analyzer's front panel.

PATTERNS

PRBS

63 (2⁶ - 1). Feedback taps on bits 5 and 6.
511 (2⁹ - 1) per O.153.
2047 (2¹¹ - 1) per O.153.
2¹⁵ - 1 per O.151.
2²⁰ - 1 per O.153.
Polarity may be inverted on all PRBS patterns.

Fixed Patterns

Permanent mark.
Alternating mark/space (ratio 1:1).
3 to 16 bit user-definable word.

FOX Message

A repetitive FOX message is provided as a confidence check in asynchronous mode but no measurements are performed on it.

A different choice of character codes is possible depending on the character length selected.

5 bit: Baudot

6 bit: BCDIC, EBCD, IPARS or Transcode

7 bit: ASCII

8 bit: ASCII or EBCDIC

XON-XOFF flow control can be enabled with ASCII or EBCDIC character codes.

The FOX message is "THE QUICK BROWN FOX JUMPS OVER THE LAZY DOG 0123456789" followed by a carriage return and line feed.

MEASUREMENTS

Measurement Types

BER Measurements Bit errors. Counting is not inhibited during alarm conditions. With Option H08, Bit errors are suppressed during pattern sync loss.
Alarm duration.

Other Measurements TX and RX frequency.
Control circuit timing.

BER Measurement Operation

General BER measurements are made over a specified test period controlled by the START/STOP key.

START/STOP Pressing the START/STOP key once starts the measurement. Pressing the START/STOP key again stops the measurement if it has not yet finished.

Test Period

Continuous	Test period manually controlled by user.
Timed	Interval 1 to 100 seconds, 1 to 100 minutes, 1 to 100 hours or 1 to 10 0 days depending on selected resolution. Interval resolution selectable as seconds, minutes, hours or days.
Bit	Interval 1En bits, $n = 4$ to 10.
Indicator	Green LED above START/STOP key is illuminated while BER measurement is in progress.
Elapsed Test Period	Part of all BER and frequency measurement displays. Shown as <i>Elapsed Time</i> for Continuous or Timed test periods. Shown as <i>Elapsed Bits</i> for Bit test periods. Display is frozen at the end of the test period and cleared when the next BER measurement is started.

Bit Error Results

See Appendix B for a list of Bit Error Results.

Alarm Duration

See Appendix D for a list of Alarm Durations.

Frequency

Operation	TX and RX frequency measurement. Synchronous mode only. 1 Hz resolution. Accuracy ± 10 ppm ± 1 count. Ageing ± 2 ppm per year typical.
Display Format	Two 7-digit displays, updated every second.

Control Circuit Timing

Control circuit timing allows the user to examine in detail the states of control circuits on the currently selected interface. Its operation is similar to that of a logic analyzer.

There are two main features:

1. Graphic display of the control circuits over time.
2. Time delay measurement.

The display sweep can be triggered manually or by a user-specified event (event A). When triggered by event A, the time delay between the start of the sweep and a second event (event B) is measured and displayed. An event consists of an OFF-ON or ON-OFF transition on a single control circuit.

Control circuit timing always uses the circuit names for the currently selected interface. These are different for each interface but for simplicity only V.24 circuit names are used below.

Control circuit timing is not available with X.21 Leased operation and 19.2 kbit/s async operation.

Control circuit timing can be found on the Control Circuits RESULTS page.

Sweep Trigger	Manual. A single sweep is triggered when the sweep control is set to RUN. Single on A. A single sweep is triggered by event A. Repeat on A. The sweep is repeatedly triggered by event A. Each sweep runs to completion before the next sweep can be triggered.
Sweep Range	100 ms, 1 s or 10 s.
Sweep Control	RUN triggers a manual sweep immediately or initiates the sweep to trigger on event A. Single sweeps stop automatically at the end of their range. MANUAL STOP can be used to stop the sweep on demand.

Delay Measurement

Measures the time between event A and event B. Fixed RTS/CTS. Event A is an OFF-ON transition on RTS; event B is an OFF-ON transition on CTS. User Selected. Events A and B are independently configurable.

Measurement is only valid within the selected sweep range.

Resolution as follows:

Range 100ms, 1s: 0.1 ms

Range 10s: 1 ms

Events

Control circuit: RTS, CTS, DTR, DSR or DCD. Also the monitor point (MON) in V.24 mode.

OFF-ON (▲) or ON-OFF (▼) transition.

If events A and B are the same a delay of 0 s will be measured.

Events A and B are marked on the graph beside their respective traces.

Glitch Detection

Pulses shorter than 1/100 of the sweep range but longer than 0.1 ms are shown as dotted vertical lines on the timing graph.

G.821 ANALYSIS

See Appendix C for information on G.821 Analysis.

STORED MEASUREMENT GRAPHICS

37732A Stored Measurement Graphics is an extension to the feature specified in the HP 37722A Digital Telecom Analyzer Operating Manual. The following specification, which applies to datacom testing, should therefore be treated as complementary to the Telecom specification.

Information on how to store measurement graphics is given in Section 4 *Printing BER Results and Settings*.

Graphs

General

Two error source histograms displayed or printed versus time.

User can choose which two error sources are to be shown.

Sampling resolution is selectable - 1 minute or 15 minutes.

Graphs of the current measurement are only available if storage has been enabled by the user.

Error Sources

Bit errors.

Block errors.

Alarms:

Power Loss, Data Loss, Pattern Sync Loss and Clock Slips.

Display Format

Width: 60 bars.
Bar resolution: 1, 15 or 60 minutes.
Bar resolution \geq sampling resolution
Error count scale is pseudo logarithmic with a range of more than 8 decades, each decade being represented linearly.
Alarm is solid bar indicating loss, opposite alarm label.
Cursor width: 30 bars (1 min resolution), 4 bars (15 min resolution) or 1 bar (60 min resolution).
Cursor moved left or right using the cursor keys.
Earlier data can be displayed by moving the cursor beyond the extreme left of the current display. 30 bars of data will move in from the left and the cursor will be repositioned to the left of display center.
Later data can be displayed by moving the cursor beyond the extreme right of the current display. 30 bars of data will move in from the right and the cursor will be repositioned to the right of display center.

Text Results

General

Settings and results are stored at the end of a BER measurement.
All settings on main and OTHER datacom pages are stored except those relating to the FOX pattern.
Results stored:
Alarm Seconds, Bit Error Results and G.821 Analysis (where applicable).

Storage

General

Storage can be enabled or disabled by the user.
Up to 10 tests can be stored.

Total capacity varies according to sampling resolution:

1 min: 32 hours max

15 min: 480 hours max

Tests with different sampling resolutions can be mixed within the store.

When remaining store capacity has been used, data from previous tests will be overwritten.

Tests may be deleted singly or all together.

No lock mechanism for individual tests

Telecom test data marked 'T', datacom test data marked 'D'.

TIME FUNCTIONS

Real-Time Clock

Stability

Crystal controlled $\pm 0.01\%$ nominal at room temperature.

Display Format

Time example: 14:06:57

Date example: 24-JAN-86

Set-up

Both time and date can be set when no BER measurement is in progress.

Elapsed Time

Function	Monitors time which has elapsed since the start of the current test period.
Display Format	Elapsed time example: 00d 01h 41m 27s Updated every second. Display is frozen at the end of the test period and cleared when the next BER measurement is started.

STORED SETTINGS

General	Stored settings are complete instrument setups stored in non-volatile memory.
User Settings	Up to ten settings can be stored - five telecom settings and five datacom settings. Settings are numbered, but can be named by the user. User settings can be saved or recalled. A lock prevents settings from being accidentally overwritten.

Factory Default Settings Cannot be changed.
Recalling factory default settings returns both T1 and datacom settings to their default states.

DATA LOGGING

Refer to Section 4 *Printing BER Results and Settings* for information on how to log data directly to a Printer.

PRINTER & REMOTE CONTROL PORT

Refer to Section 7 *Installation* for information on the Printer and Remote Control port.

USER CONFIDENCE TESTS

There are two sets of self tests to give the user a high confidence level that the instrument operates to specification. They also provide service information for fault location.

Digital Telecom Analyzer self tests can be found on the Self Test OTHER page while telecom testing is selected.

Datacom Module self tests can be found on the Self Test OTHER page while datacom testing is selected.

POWER SUPPLY

General Power supply as specified for the 37722A Digital Telecom Analyzer.

Power Consumption Datacom Module adds 10 VA to Digital Telecom Analyzer.
Total 60 VA for combined Telecom/Datacom Analyzer
without battery power (Option B12).

PHYSICAL

Dimensions

Telecom/Datacom Analyzer 340 mm wide x 190 mm high x 155 mm deep.
Battery power (Option B12) adds 64 mm to depth.

Datacom Module 340 mm wide x 175 mm high x 55 mm deep.

Weight

Digital Telecom Analyzer 4.5 kg.
Battery power (Option B12) adds 2.6 kg.

Datacom Module 1.4 kg.

Environment

HP Class B1 with reduced operating temperature range of 0 to 50°C.
The recommended warm-up time for this instrument is 15 minutes.

Installation

Introduction

This section provides installation instructions for the Hewlett-Packard Model 37732A Telecom/Datacom Analyzer and the HP 15901A Option 001 Datacom Module when fitted to the HP 37722A Digital Telecom Analyzer. This section also includes information about initial inspection, preparation for use, packaging, storage and shipment.

Initial Inspection

Warning To avoid hazardous electrical shock, do not perform electrical tests when there are signs of shipping damage to any portion of the outer enclosure (covers, panels, meters and so on).

Inspect the shipping container for damage. If the shipping container or cushioning material is damaged, it should be kept until the contents of the shipment have been checked for completeness and the instrument has been checked mechanically and electrically. Procedures for checking electrical performance are given in Chapter 8 of this manual. If the contents are incomplete, if there is mechanical damage or defect or if the instrument does not pass the Performance Tests, notify the nearest Hewlett-Packard office. If the shipping container is damaged or the cushioning material shows signs of stress, notify the carrier as well as the Hewlett-Packard office. Keep the shipping materials for the carrier's inspection. The HP office will arrange for repair or replacement at HP option without waiting for claim settlement.

Preparation for Use

Warning



To avoid the possibility of injury or death, the following precautions must be followed before the instrument is switched on.

- A. Note that the protection provided by grounding the instrument cabinet may be lost if any power cable other than the three-pronged type supplied is used to couple the ac line voltage to the instrument.
 - B. If this instrument is to be energized via an auto-transformer to reduce or increase the line voltage, make sure that the common terminal is connected to the neutral pole of the power source.
 - C. The power cable plug shall only be inserted into a socket outlet provided with a protective earth contact. The protective action must not be negated by the use of an extension cord without a protective conductor (grounding).
 - D. For operator protection during battery operation, connect the chassis terminal on the rear panel to earth ground.
-

Power Requirements

The instrument requires a power source of 95 to 240V ac $\pm 10\%$, 48 to 66 Hz single phase, or can be powered from a Battery (Option B12). The instruments power consumption is less than 60 VA.

Line Fuses

Two line fuses are required, they are located in in the line power input module on the side panel. The correct rating is 250V, 1 A Timed (HP 2110-0782).

Caution



Before connecting the instrument to a power outlet ensure that the fuses are correctly rated.

Power Cable

This instrument is equipped with a three-wire power cable. When connected to a properly grounded power outlet, this cable grounds the instrument case. The type of power cable supplied with each instrument depends on the country of destination. Refer to the following figure for the part numbers of the power cables and plug configurations available. If the appropriate power cable is not included with the instrument, notify the nearest Hewlett-Packard Sales and Service Office and a replacement will be provided.

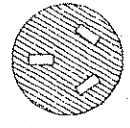
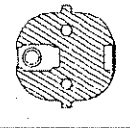
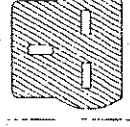
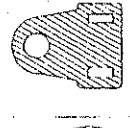
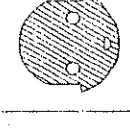
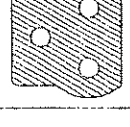
	8120-2104		8120-1369		8120-1689		8120-1355		8120-1578 US 8120-4753 JAP.		8120-2956		8120-4211
---	-----------	--	-----------	---	-----------	---	-----------	---	--------------------------------	---	-----------	---	-----------

The color code used in each power cable is given below:

Line Brown
Neutral Blue
Ground Green/yellow

Battery (Option B12)

Warning For operator protection during battery operation, connect the chassis terminal on the rear panel to earth ground.



Two 6 V 3 Ah lead acid batteries (HP 1420-0123) are located inside the battery compartment at the rear of the instrument.

The instrument will run with fully charged batteries (at an ambient temperature of 25 degrees centigrade) for nominally 1.5 hours with settings and results displayed or 2 hours with the display blanked.

Power consumption is optimized by automatically blanking the display if there is greater than 2 minutes between key presses. Pressing any key re-displays settings.

When the instrument detects that the battery voltage is low, it displays a **Battery low** !!! status message. This message remains displayed until the battery voltage drops below the minimum level that guarantees valid results. When this condition is reached, there is an automatic instrument power down and the red **LOW BATTERY** indicator on the side panel then flashes to show the batteries require re-charging.

It is recommended that the batteries be re-charged as soon as possible to optimize battery life.

To Charge the Batteries (Option B12)

Caution



To avoid over charging, do not use an external charger. The instrument has its own charging circuit.

Connect the ac power cord, the green **CHARGING** indicator lights - full charge is obtained after 9 hours at 25 degrees centigrade. The battery charges with the power switch in the **ON** or **STANDBY** position.

To Change the Batteries

Warning



The battery should only be changed by someone who is aware of the hazards involved.

Do not short circuit the battery terminals, it may cause serious personal injury.

Do not incinerate or otherwise mutilate the battery. It might burst or release toxic materials causing personal injury.

1. Ensure that the instrument power switch is set to *STANDBY* and disconnect the ac power cord (if one is connected).
2. Remove the eleven securing screws on the rear panel then remove the back-plate.

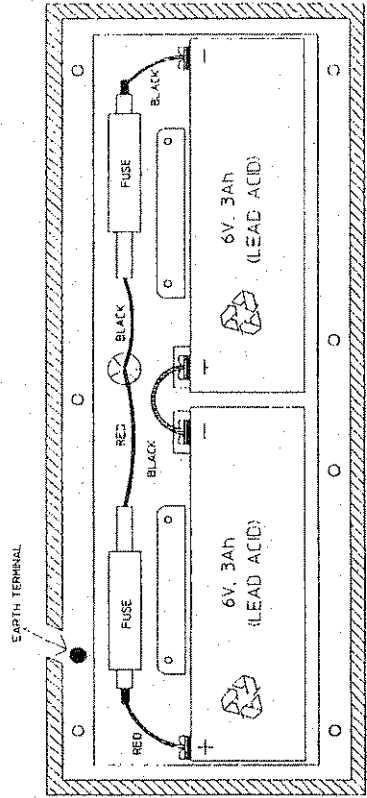

3. Disconnect the batteries.
4. Replace the batteries.
5. Re-connect the new batteries.

Battery Fuses

Two 5 A fast blow fuses (HP 2110-0010) are located inside the battery compartment at the rear of the instrument (see figure above).

To Change a Blown Fuse

1. Ensure that the instrument power switch is set to *STANDBY* and disconnect the ac power cord (if one is connected).
2. Remove the eleven securing screws on the rear panel then remove the back-plate.
3. Disconnect the batteries.

4. Replace blown fuse.
5. Re-connect the batteries.

Mating Connectors (Front Panel)

Connectors which mate with the Telecom/Datacom Analyzer are listed below.

Telecom/Datacom Analyzer Port	Connector type	Mating Connector Part Number
CLOCK OUT	BNC	1250-1448
SIGNAL OUT	Siemens (3-pin)	1252-3033
SIGNAL OUT	BNC	1250-1448
CLOCK IN	BNC	2150-1448
SIGNAL IN	Siemens (3-pin)	1252-3033
SIGNAL IN	BNC	1250-1448
RS-232	25 W D SUBMIN	HP 1251-0063 (plug) HP 1251-1438 (hood)

Connectors which mate with the Datacom Module are listed below.

Telecom/Datacom Analyzer Port	Connector type	Mating Connector Part Number
RS-232/V.24	25 W SUBMIN	HP 1251-0063 (plug) HP 1251-1438 (hood)
V.35		*VMCT34M00P0Y0 (connector) MS120N (pins, 12 off)
RS-449/V.11	37 W SUBMIN	HP 1251-4586 (plug) HP 1251-2368 (hood)

* Positronic Industries Part Number

Installing the Datacom Module

Use the four screws provided to attach the HP 15901A Option 001 Datacom Module to the bottom (front frame) of the HP 37722A Digital Telecom Analyzer.

ACCESSORY Port - for Datacom Module Connection

Caution

The Datacom Module cable must only be connected or disconnected with the instrument powered down.



The Datacom Module cable must be properly connected to the *ACCESSORY* port on the side panel of the HP 37722A or HP 37732A before either can be configured as Datacom Analyzer.

RS-232 Port - for Printer or Remote Control Connection

Caution

This port is located on the side panel of the HP 37732A or HP 37722A and is **NOT** to be confused with the RS-232/V.24 port on the Datacom Module.



This port is a full duplex RS-232C serial interface configured as Data Communications Equipment (DCE). This port can be connected directly to printers, dumb terminals and controllers which are configured as Data Terminal Equipment (DTE).

Using an adapter cable (see page 7-9), this port can also be connected to modems and other devices which are configured as DCE.

The RS-232 connector pinout configuration and signal flow are shown in the following diagram:

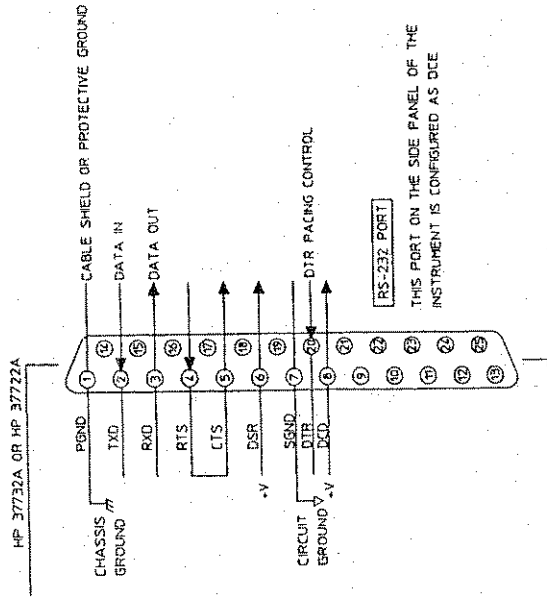

The RS-232 port can only transmit or receive asynchronous data, any device connected to it must be set for asynchronous operation. The character formats for Printer and Remote Control are as follows:

	Printer Operation	Remote Control
Baud Rate	300, 600, 1200, 1800, 2400, 4800 or 9600	
Data Bits	8	7
Parity	None	Odd, Even, Zeros, Ones
Stop Bits		1 or 2
Pacing	ENQ/ACK, Xon/Xoff or DTR	ENQ/ACK, Xon/Xoff (RX only) (TX only) (RX & TX or off)

For more details on Printer operation and Remote Control, see Chapters 4 and 9 respectively.

Modem Connection

Only a full duplex modem may be used. The cable connecting the RS-232 port to the modem should be configured as follows:

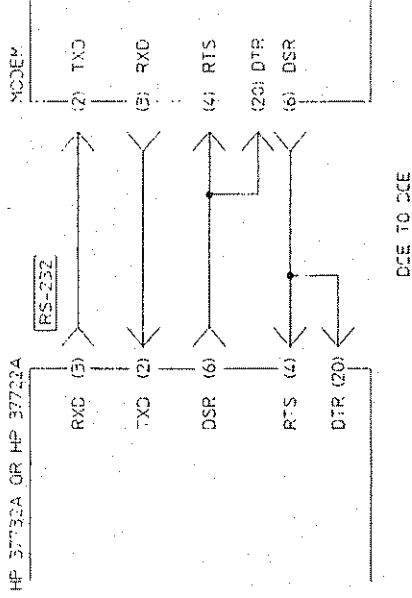

Rack Mounts

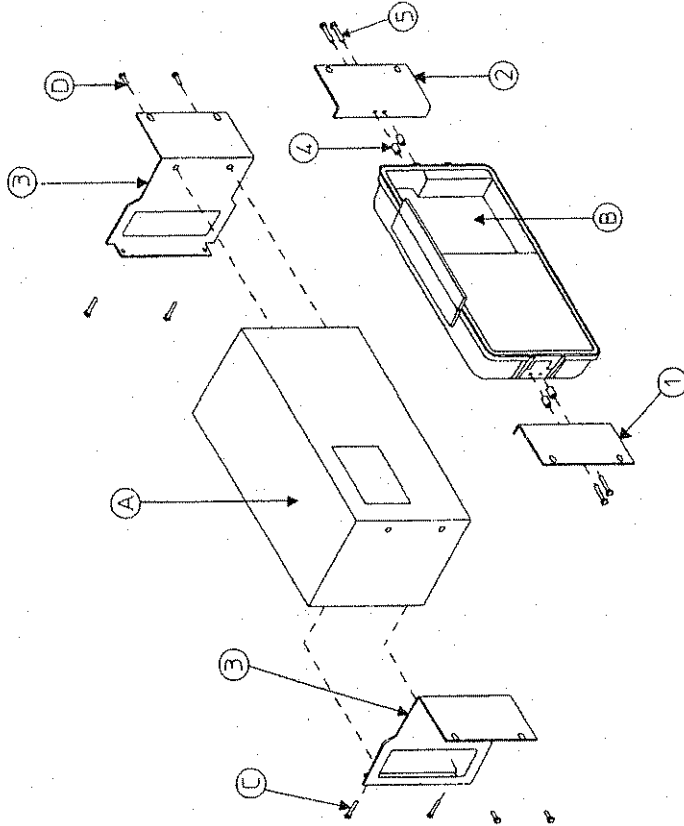

PROCEDURE FOR MOUNTING BRACKETS TO (A)

1. REMOVE 4 SCREWS (C) HOLDING REAR FEET
2. REMOVE 12 SCREWS (D) HOLDING FRONT FEET
3. PLACE BRACKETS ITEM 3 (2 OFF) IN POSITION AND FIX USING EXISTING SCR (4 OFF 'C') FROM THE REAR FEET AND (4 OFF 'D') FROM THE FRONT FEET

PROCEDURE FOR MOUNTING BRACKETS TO (B)

1. REMOVE 4 SCREWS BENEATH LATCH CATCH AND REMOVE DATAIDN ASSY FROM THE PLASTIC COVER
2. REMOVE THE LATCH CATCHES BY REMOVING THE NUTS AND WASHERS ON THE INSIDE OF THE PLASTIC COVER
3. REET DATAIDN ASSY INSIDE PLASTIC COVER
4. PLACE BRACKETS ITEMS 1 & 2 IN POSITION AND FIX USING SCREWS ITEM 5 (4 OFF) AND SPACERS ITEM 4 (4 OFF)

RACK MOUNT KITS				
ITEM	QTY	DESCRIPTION	KIT No.	HP PART No.
1	1	BRACKET	HP 15713A	HP 15713A
2	1	BRACKET	37701-00031	37701-00031
3	2	BRACKET	37701-00032	37701-00032
			37701-00029	37701-00029
			HP 37732A	HP 15901A
			HP 15711A	HP 15711A
			HP 15715A	HP 15715A
			37701-00031	37701-00031
			37701-00032	37701-00032
			37701-00029	37701-00029

Operating Environment

- Temperature** The instrument may be operated in temperatures from 0 degrees centigrade to +50 degrees centigrade. The temperature for battery operation is 0 degrees centigrade to +40 degrees centigrade.
- Humidity** The instrument may be operated in environments with humidity up to 95% at 40 degrees centigrade. However, the instrument should also be protected from temperature extremes which may cause condensation within the instrument.
- Altitude** The instrument may be operated at altitudes up to 4,600m (15,000 ft).
- Air Flow** To provide adequate cooling, an air gap of approximately 3-inches should be maintained around the instrument.

Storage and Shipment

Environment

The instrument may be stored or shipped in environments within the following limits:

- Temperature** -40 degrees centigrade to +75 degrees centigrade without a battery and -20 degrees centigrade to +55 degrees centigrade with a battery.
- Humidity** 90%
- Altitude** 15,300m (50,000 ft)

The instrument should also be protected from temperature extremes which may cause condensation within the instrument.

Packaging

Tagging for Service

If the instrument is being returned to Hewlett-Packard for service, please complete one of the blue repair tags located at the front of the service manual (if you have one) or give details on a label then attach the tag or label to the instrument.

Original Packaging

Containers and material identical to those used in the factory packaging are available through Hewlett-Packard offices. If the instrument is being returned to Hewlett-Packard for servicing, attach a tag indicating the type of service required, return address, model number and full serial number. Also mark the container "FRAGILE" to ensure careful handling.

Other Packaging

The following general instructions should be used for re-packing with commercially available materials:

- a. Wrap instrument in heavy paper or plastic. (If shipping to Hewlett-Packard office or service center, attach a tag indicating type of service required, return address, model number and full serial number.)
- b. Use strong shipping container. A double-walled carton of 35-pound test material is adequate.
- c. Use a layer of shock absorbing material 70 to 100 mm (3 to 4 inch) thick around all sides of the instrument to provide firm cushioning and prevent movement inside the container. Protect the control panel with the front cover provided or with cardboard.
- d. Seal shipping container securely.
- e. Mark the shipping container clearly.
- f. In any correspondence, refer to instrument by model number and full serial number.

Performance Tests

Introduction

The following procedures check the electrical performance of the Datacom part of the HP 37732A Telecom/Datacom Analyzer or the HP 15901A Option 001 Datacom Module when fitted to the HP 37722A Digital Telecom Analyzer to the specifications listed in Chapter 6.

If any of the following tests fail, carry out the adjustments for *Transmit Clock Frequency* described in the HP 37732A Service Manual. If this fails to correct the problem, refer to the troubleshooting section of the Service Manual or return the instrument to the nearest HP Service Office.

Calibration Cycle

Results recorded on the Test Record at incoming inspection can be used for comparison in yearly maintenance and calibration or after repairs or adjustments.

Recommended Test Equipment

The test equipment required is listed in the following table. Equipment which meets or exceeds the critical specifications may be substituted for the recommended model.

Instrument	Critical Specification	Recommended Model
Frequency Counter	0.00015% accuracy up to 2.048 MHz	HP 5316B Option 001
RS-232/V.24 Mating Connector	_____	HP 1251-0063
RS-449/V.11 Mating Connector	_____	HP 1251-4586
10:1 Divider Probe	_____	HP 10435A
Test Pin (2 off)	_____	HP 0360-0535
24 Gauge Jumpered Wire	_____	

Datacom Module Self Test

Description

These tests give a high degree of confidence that the Datacom part of the HP 37732A Telecom/Datacom Analyzer or the HP 15901A Option 001 Datacom Module when fitted to the HP 37722A Digital Telecom Analyzer is operating to its warranted specification. A table listing each test and its associated Fail Code Group is given on page 8-6.

Equipment

RS-232/V.24 Mating Connector : HP 1251-0063
V.35 Loopback Connections * : Refer to Procedure step 5
RS-449/V.11 Mating Connector : HP 1251-4586
24 Gauge Jumpered Wire

*See Section 7 (Installation) for the manufacturers V.35 mating connector part numbers. These parts can be used to construct a V.35 loopback connector with the connections listed in step 5 of the following procedure made.

Procedure

1. Set the instrument power switch to OFF.

Caution The Datacom-lid cable must only be connected or disconnected with the instrument powered down.



2. Connect the Datacom Module to the ACCESSORY port on the side of the instrument.
3. Use wire links to make connections between pins on the RS-232/V.24 Mating Connector as shown in the following figure:

Datacom Module Self Test

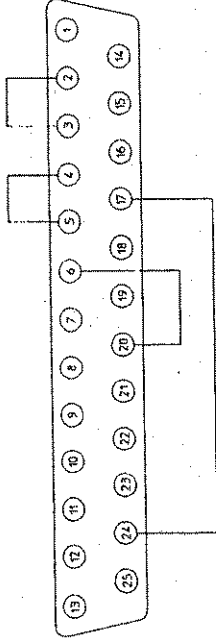

4. Connect the modified RS-232/V.24 Mating Connector to the Datacom Module RS-232/V.24 interface.
5. Use 24 gauge jumpered wire to make connections directly across the V.35 interface as shown in the following figure:

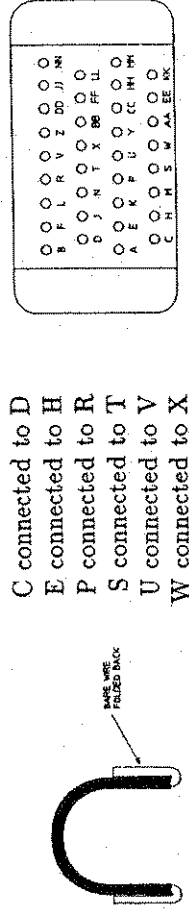

C connected to D
 E connected to H
 P connected to R
 S connected to T
 U connected to V
 W connected to X

6. Use wire links to make connections between pins on the RS-449/V.11 Mating Connector as follows:

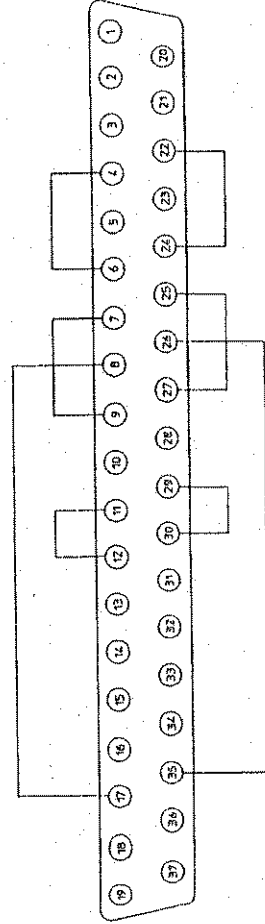

7. Connect the modified RS-449/V.11 Mating Connector to the Datacom Module RS-449/V.11 interface.
8. Power the instrument ON.

Datacom Module Self Test

9. Press **TEST SELECT** on the Datacom Module to select **DATAKOM** (if required).
10. Press **OTHER** followed by **MORE** ; then select **SELF TEST** . Set the **TEST TYPE** for **ALL TESTS** .
11. Press **START/STOP** and verify that **TEST STATUS PASSED** is displayed at the end of **ALL TESTS**, approximately 2 minutes.

Note



A Datacom Module Self Test failure may not be due to the datacom module - it may be due to a fault on the HP 37722A or the HP 37732A to which it is connected. If Datacom Self Test fails, go to Chapter 9 of the Telecom Analyzer Operating and Calibration manual and perform the Telecom Analyzer Self Tests. If it passes, then run each of the Datacom Module Self Tests individually to discover the extent of the malfunction. Refer to the Service Manual Troubleshooting to find out how to correct this failure.

Datacom Module Self Test, Order and Fail Codes

When ALL TESTS is selected the individual tests (1 to 4) are performed in the order shown in the following table. Tests 1 to 3 use a comparison of measured results and expected results. The measurements are made on signals which are internally looped back from transmitter to receiver. Test 4 uses the same method except that an external loopback has to be made on each datacom interface. If a test failure occurs, the failure code displayed indicates the part of the individual test which has failed. The test which failed is indicated by the group of failure codes shown in the following table.

Fail Code Group	Test	Test Number
100 to 199	CPU	1
200 to 299	SYNTH	2
300 to 399	ASYNC	3
400 to 499	INTERFACE	4

Internal Synthesizer Rates

Specifications

Synthesizer Rates

Preset Rates: 1.2 kbit/s, 19.2 kbit/s, 1.984 Mbit/s
Preset Accuracy: ± 10 ppm. (± 5 ppm nominal from 0 to 40°C)
User defined rate: 600 bit/s, 1.024 Mbit/s, 2.048 Mbit/s.
User defined accuracy: $\pm 0.01\%$
Ageing: ± 2 ppm per year typical.

Description

This test verifies that the internal synthesizer can generate Preset transmit data rates to within 12 ppm providing that the instrument has been through its yearly calibration and that User defined rates meet specification.

Equipment

Frequency Counter : HP 5316B Option 001
10:1 Divider Probe : HP 10435A
RS-449/V.11 Mating Connector : HP 1251-4586
Test Pin (2 off) : HP 0360-0535

Procedure

1. Set the instrument power switch to OFF.

Caution

The Datacom-lid cable must only be connected or disconnected with the instrument powered down.



2. Connect the Test Pins to pin 17 and pin 19 of the RS-449/V.11 Mating Connector respectively.

Internal Synthesizer Rates

3. Connect the modified RS-449/V.11 Mating Connector to the Datacom Module RS-449/V.11 interface.
4. Use the 10:1 Divider Probe to connect the Frequency Counter to pin 17 of the modified RS-449/V.11 Mating Connector - the probe ground should be connected to pin 19.
5. Connect the Datacom Module to the *ACCESSORY* port on the side of the instrument.
6. Power the instrument ON.
7. Press **TEST SELECT** on the Datacom Module to select *DATAKOM* (if required).
8. Press **SETTINGS** to display the currently set parameters.
9. Use **←**, **→** and the softkeys to set the parameters as shown in the following figure:

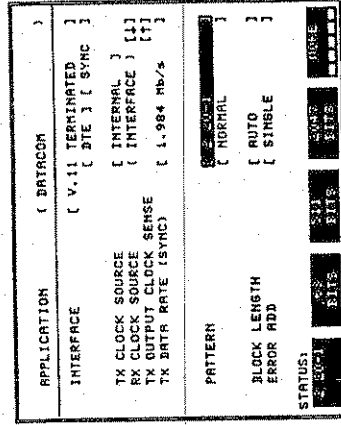

Internal Synthesizer Rates

PRESET TX DATA RATES

10. Use **1** and **2** to highlight the TX DATA RATE (SYNC) setting.
11. Select TX DATA RATE (SYNC) as listed in the table below and check that the associated Frequency Counter reading is within the limits listed in the right hand column of the following table.

TX DATA RATE (SYNC)	Freq Counter reading
1.984 Mb/s	$1.984 \times 10^6 \text{ Hz} \pm 23.8 \text{ Hz}$
19.2 kb/s	$19.2 \times 10^3 \text{ Hz} \pm 0.230 \text{ Hz}$
1200 b/s	$1.2 \times 10^3 \text{ Hz} \pm 0.0144 \text{ Hz}$

USER DEFINED TX DATA RATES

12. Set the TX DATA RATE (SYNC) for USER PROGRAM - note that an additional data rate setting appears.
13. Set the USER PROGRAM settings as listed in the table below, check that the associated Frequency Counter reading is within the limits listed in the right hand column of the table:

USER PROGRAM Setting	Freq Counter reading
600 b/s	$600 \text{ Hz} \pm 0.06 \text{ Hz}$
1024000 b/s	$1.024 \times 10^6 \text{ Hz} \pm 102.4 \text{ Hz}$
2048000 b/s	$2.048 \times 10^6 \text{ Hz} \pm 204.8 \text{ Hz}$

Test Record

Hewlett-Packard Model 87792A Telecom/Datacom Analyzer

Location: Serial No.:
Tested by:
Temperature: Certified by:
Humidity: Date:

Performance Test Record

Page No.	Test Description	Result		
		Min	Actual	Max
8-3	Datacom Module Self Test Step 11 TEST STATUS PASSED (✓)		
8-7	Internal Synthesizer Rates			
8-9	PRESET TX DATA RATES			
	Step 11			
	1.536 Mb/s	1,983,976.2 Hz	1,984,023.8 Hz
	19.2 kb/s	19,199.770 Hz	19,200.230 Hz
	1200b/s	1,199.9856 Hz	1200.0144Hz
8-9	USER DEFINED TX DATA RATES			
	Step 13			
	600 b/s	599.94 Hz	600.06 Hz
	1.024 Mb/s	1,023,897.6 Hz	1,024,102.4 Hz
	2.048 Mb/s	2,047,795.2 Hz	2,048,204.8 Hz

Remote Control

There are three forms of remote control available:

- Virtual remote, (option V01) using software HP 15800A. This provides operation via a front panel displayed on a workstation, the keys being operated with a mouse. Separate documentation is supplied for this type of remote operation.
- RS-232-C commands from a terminal or computer.
- HP-IB commands from a computer (option H01)

Tests may be set up and run, results may be stored and retrieved, using the remote control facility. The operation of the Analyzer is the same as in manual operation from the front panel.

Additional facilities are available when using remote control:

Complete test configurations may be down loaded to the Analyzer either for immediate use or to be stored in the analyzer memory for future use.

Results may be returned to the controller for display, printing or further analysis.

Preparation for Remote Control

The Analyzer may be controlled directly from a controller at the same location as the Analyzer, or over a telephone link via modems.

Where control is over a telephone link, the link may be a leased line or a dial-up line.

The controller may be a "dumb" terminal or a computer.

The Analyzer must be correctly connected and correctly set up for successful remote control.

The RS232C port may be configured for either printer or remote control operation. When printer operation is selected, 8 bit data is transmitted and Xon/Xoff selection may be "ON" or "OFF" only. When remote control operation is selected, 7 bit data is assumed and Xon/Xoff selections are :

OFF, Rx ONLY, Tx ONLY or Rx AND Tx.

The analyzer receive buffer has a capacity of 128 bytes.

Remote Control / Printer Pin Assignments

Pin	Mnemonic	Description
1	PGND	Connected to chassis ground
2	TXD	37732A data input
3	RXD	37732A data output
4	RTS	Looped to pin 5
5	CTS	Looped to pin 4
7	SGND	Signal ground
20	DTR	Inhibits data output from the 37732A when held "OFF" by the receiving device.

To Connect to Telephone Lines via Modems

The connections of a cable suitable for Analyzer / modem connection are shown in the following figure.

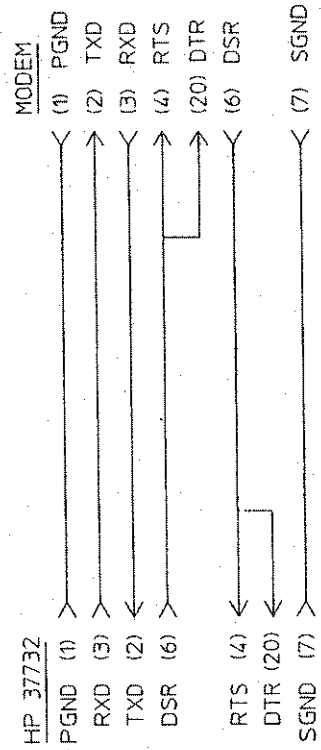

To Connect for Direct Operation

The connections of a cable suitable for direct connection to a controller are shown in the following figure.

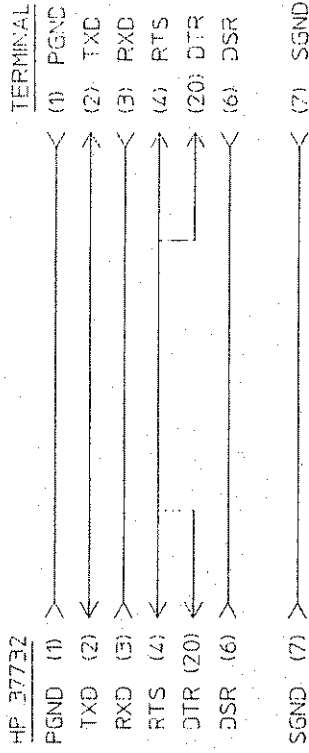

To Set the Analyzer for Operation from a Terminal

Press **OTHER**

Select **RS 232 PORT**

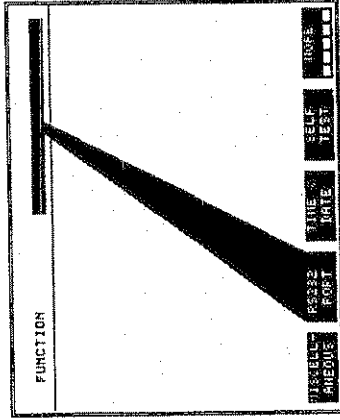

Highlight

RS232 []

Select **TERMINAL CONTROL**

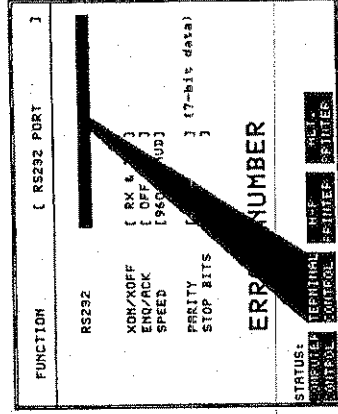

To Set the Analyzer for Operation from a Computer

Press **OTHER**

Select **RS 232 PORT**

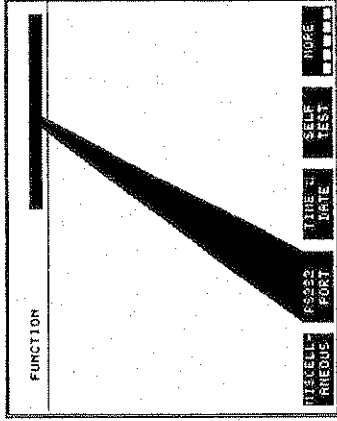

Highlight

RS232 []

Select **COMPUTER CONTROL**

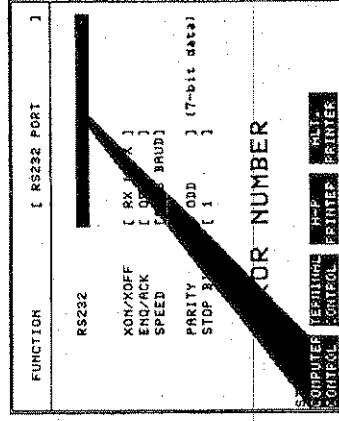

Remote Operation

The following information assumes the user is familiar with the local operation of the analyzer.

Remote operation is performed by a computer or "dumb" terminal connected to the RS 232 C port on the side of the analyzer. This port is also used as the printer output port. The printing of results may be performed by returning the results to the computer or printing terminal, or alternatively by storing them in the analyzer for printing at a later time.

The analyzer is operated by commands which are listed later in this chapter. Commands are shown in the actual form required and are presented in "computer type" for example the command for starting a test is shown as STR.

Many commands must be qualified with a variable for example the command DTI which selects the interface timing type as has a qualifier *n* which specifies the type of interface, asynchronous or synchronous.

The qualifier *n* is presented in italic type.

The preferred form of the complete command has a space between the mnemonic and the variable. For example DTI 1 is preferred to DTI1.

The possible alternative values for *n* are presented as a list. There is usually a choice in the form of the variable, a digit or an alpha-numeric code.

The command information for setting the interface timing type to asynchronous or synchronous is presented in the following form:

DTI <i>n</i>	<i>n</i> =	1 or ASYNC	Asynchronous timing
		2 or SYNC	Synchronous timing

To set the interface to Asynchronous send: DTI 1 or DTI ASYNC

To set the interface to Synchronous send: DTI 2 or DTI SYNC

A space between the mnemonic part of the command (DTI) and the variable (*n*) is desirable.

In local operation, all of the front panel controls are responsive and control the analyzer. In remote operation the controls which change parameters are inoperative, the analyzer being controlled by the remote controller. The front panel display reflects the remote programming commands received.

At power on the analyzer assumes the local state. Under local control all remote commands will be ignored. To gain control of the analyzer the controller must put the analyzer into the remote state. This is accomplished by sending the "remote control enable" command (RMT). The analyzer can be returned to local control by sending the "return to local" command (LCL), or by power cycling the instrument.

Commands are normally separated by "newlines" which can be either a single carriage return character or a carriage return-line feed pair.

Note that line feeds are always ignored in input. It is possible to put multiple commands on one line by separating them with semicolons. Output lines are always separated by carriage return-line feed pairs, regardless of which separator was used on input. This is different to "computer mode", where the separator used for output is always the same as was used for input.

The length of an input line is limited to 80 characters. If the user tries to type more than 78 characters (the last two are used to store the CR LF), the terminal bell rings and the extra characters are discarded.

Terminal Control

In general this chapter describes how to control the analyzer under computer control. The differences when using a terminal are given here.

The operational differences with terminal use are :

- Characters typed are echoed to the terminal.
- The analyzer provides a prompt at the beginning of the command line.
 - * Rudimentary input editing (backspace, erase line) is provided. * An asynchronous interrupt (quit) is provided.
- Errors are reported as text messages.
- A command history is provided.
- Status bit queries indicate active bits in mnemonic form.
- Queries of instrument configuration will return text values.

Prompting and Input Editing

The Prompt

With terminal operation, the analyzer provides a prompt which is displayed on the terminal screen. This prompt may be customized by the user using the ID command. The preset prompt is :

HP37732A>

Input Editing

There are three special function characters used for input editing :

BACKSPACE This character (DELETE) causes the last character typed to be erased (the analyzer outputs BACKSPACE-SPACE-**BACKSPACE**). If the user attempts to backspace over the prompt, the terminal bell rings.

KILL This character (control-U) causes all of the line from the prompt to the end to be erased.

INTERRUPT This character (control-C) interrupts the execution of the current command and the analyzer outputs a newline followed by a prompt. Pressing **BREAK** has the same effect.

Error Reporting

When using "computer" mode, errors in parsing or execution cause the processing of the current command to cease, and an error code describing the nature of the problem is placed in the error register, which the user can examine by issuing the ERR? command. In "dumb terminal" mode, the analyzer reports errors when they occur, without the user performing any special action. When an error occurs, the analyzer will echo the faulty command with a text message explaining what the problem was.

Examples :

Example 1 : IDX? sent instead of ID?.

HP37732A> idx?

idx? : Command header error

Example 2 : A command sent when the analyzer was not under remote control.

```
HP37732A> rst
rst : Command not executable in local mode
```

Example 3 : A mixture of valid and invalid commands sent.

```
HP37732A> id? ; idx?
HP37732A
idx? : Command header error
HP37732A>
```

In the third example above, a line contains one legal command (id?), and one illegal command (idx?). The legal command is executed, and the response written to the terminal, followed by an error message for the illegal command.

Note that in "dumb terminal" mode, the analyzer error register is NOT updated. This is because the analyzer effectively follows each error with an internal ERR? command, which has the effect of clearing the error register.

Mnemonic Responses

When in "computer mode", commands which query analyzer status registers (e.g. STA?, RQS? etc.) simply return integers. Where these registers are really collections of bits, each indicating a separate condition, "dumb terminal" mode will output a mnemonic string indicating which bits are active, in addition to the integer value of the register.

Example

```
HP37732A> sta?
28 <RDY LCL FPS&>
```

In addition to mnemonic responses for status register queries, "dumb terminal" mode has the facility to return mnemonic responses to selectable variable queries.

Example

```
HP37732A> cod?
HDB3
```

"dumb terminal" mode also provides a command history feature. The analyzer maintains a buffer of up to 20 commands (or 200 characters, whichever runs

out first) of commands entered. Commands are entered into the history buffer whether legal or not, and a command is only not put into the history if it is exactly the same as the last command sent. If there is no space in the history store when a new command is received, commands are deleted from the store, oldest first, until there is enough space.

Commands are provided to list the contents of the store, re-execute the last command sent and to re-execute a particular command, specified by its number. These commands are not themselves placed into the history store.

!l : Lists the contents of the history store (if any).

NOTE : The character **l** in this command must be the lower case of character **L**.

Example : Response to a request to list the contents of the history store !l

```
HP37732A> !!
1 : sta?
2 : rst
3 : id?
4 : str
5 : stp
HP37732A>
```

!! : Echoes and re-executes the last command in the history store.

Example : To re-execute the last command.

The last command in the previous example was **stp**.

Typing **!!** after the prompt will cause the **STOP** command to be returned to the terminal and re-executed.

```
HP37732> !!
stp
```

!n : Echoes and re-executes command number **n** in the history store.

The command number is either the number given by the "**!!**" command, or a negative number indicating the "second from last (-2)" etc. If the selected command is not in the store the command is echoed and an error message is written to the terminal.

The following errors can occur when using history commands :

bad history command -- unrecognized history command.

no such history command -- the specified command is not in the store.

HP-IB Operation (option H02)

The standard Telecom / Datacom Testers are provided with RS-232 printer output and remote control.

The special option H02 instruments are provided with Hewlett-Packard Interface Bus (HP-IB) printer output and remote control.

The printing and control information, including commands, in this manual, apply to both RS 232 and HP-IB. The variations in setting up the instrument for HP-IB operation are given in the following pages.

HP-IB Provides a parallel interface which allows the instrument to be incorporated into a system by the connection of other devices, for example : a Personal Computer or a Printer. Such a system allows great flexibility in communicating and controlling data.

The performance of the instrument may be extended by storing a greater number of test set-ups in the controller (or on disc) and loading them into the instrument as required. Similarly a greater number of results may be returned to the controller or printer for later analysis.

If long distance communication is required, suitable HP-IB Extenders are available. HP-IB Extenders are connected within the test system at both ends of the communication link.

Connecting to the HP-IB

The following points should be considered when connecting the instrument to the HP-IB :

- Operating distances
- Communication with the system controller

Operating Distances

To achieve interface design performance standards, restrictions are placed on the HP-IB system cable lengths. These restrictions allow the bus interface to maintain correct line voltage levels and timing relationships.

When connecting an HP-IB system the following rules should be observed :-

1. The total length of HP-IB cable must not exceed 2 meters (6 feet) \times the number of devices in the system.
2. The total length of HP-IB cable, used to interconnect all devices in the system, must not exceed 20 meters (65 feet).

Hewlett-Packard Interface Bus Connector

A standard HP-IB connector is provided on the instrument rear panel. The connections and HP-IB logic levels are shown in the following figure. The Mating connector part number is HP 1251-0293 or Amphenol 57-30240.

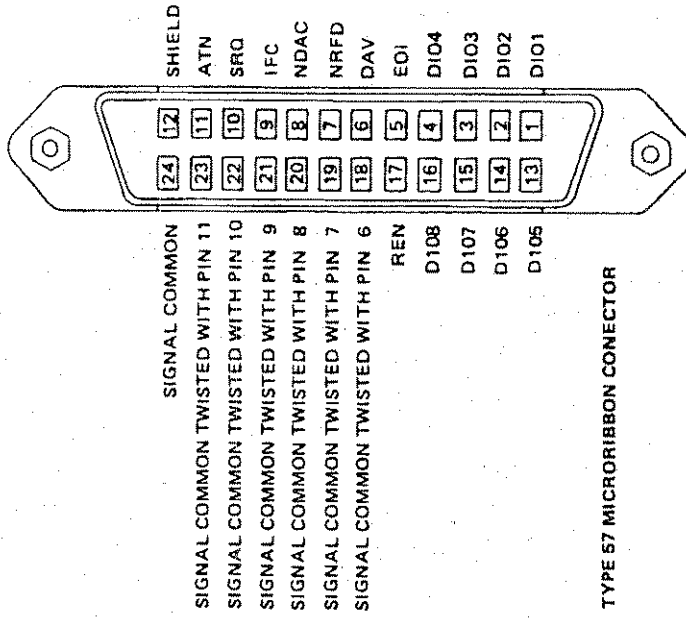

HP-IB Connections and Logic Levels

Suitable Cables

The instrument may be connected to the HP-IB with one of the following HP-IB cables.

Table 9-1. HP-IB Interconnecting Cables

Length	Accessory Number
1 meter	10833A
2 meters	10833B
4 meters	10833C
0.5 meter	10833D

Connection Over Greater Distances

Operating distances can be increased by using HP-IB Extenders, HP 37204A or HP 37201A :

Up to 1250 meters use HP 37204A.

Over 1250 meters use two HP 37201A and two suitable Modems.

Setting Up for Printing or Controlling

A printout of alarms, results and instrument settings may be obtained by connecting a printer to the HP-IB connector and selecting the TALK ONLY mode of operation.

Instrument/system control may be obtained by connecting a controller to the HP- IB connector and selecting the ADDRESSABLE mode of operation.

To Print using Talk Only

Press OTHER

Select HP-IB PORT

Highlight HP-IB

Select TALK ONLY

Use the information in chapter 6, Printing Results, to set the instrument for the type of print you want.

To Control the Instrument Remotely

Communication with the System Controller

Each device in the system must have a unique address to allow the controller to access it individually. The address is selectable from the instrument front panel.

HP-IB Address Selection

To select the HP-IB address:

Press **OTHER**

Select **HP-IB PORT**

Highlight **HP-IB** []

Select **ADDRESSABLE**

Highlight **ADDRESS** []

Select a "system unique" address in the range 1 to 30

To Return to Local Operation

There are two alternative methods of returning to local operation from remote:

By sending the **LCL** command

By selecting **OTHER**, **HP-IB PORT**, **RETURN TO LOCAL**

Status Reporting

The instruments contains 5 Registers which can be interrogated for status information. Two Status registers, A and B, Alarm register, Ready register and Error register.

To determine the current status of the instrument you must interrogate the Primary Status Byte register, Status register B. Three methods of interrogation are possible via HP-IB but only one method is available via RS-232-C. The three methods and the remote interface on which they are valid are listed below.

Method of Interrogation	HP-IB	RS-232-C
Poll using STB?	YES	YES
Repeated Serial Poll (SPOLL)	YES	NO
Poll using a Service Request interrupt routine	YES	NO

Service Request Interrupt Routine

- Select the condition(s), under which you require the instrument to Request Service by using the "RQS n" command.
- Specify the action to be taken when an interrupt is issued by using the controller dependent ENABLE INTR and ON INTR (Basic) statements.
- Acquire the Primary Status Byte using the SPOLL (basic) statement.

The printer/ remote control display used for setting the HP-IB address, gives a service request indication.

Poll Using STB?

- Select the condition(s), under which you require the instrument to Request Service by using the "RQS n" command.
- Enter a waiting loop and acquire the Primary Status Byte by using the "STB?" command.

HP-IB Capability

SH1	(complete capability)
AH1	(complete capability)
T5	(Basic talker, serial poll, talk only mode, unaddress if MLA)
TE0	(No extended talker capability)
L4	(Basic listener, unaddress if MTA)
LE0	(No extended listener capability)
SR1	(Complete SRQ capability)
RL1	(Complete remote-local capability)
PP0	(No parallel poll capability)
DC1	(Complete device clear capability)
DT0	(No device trigger capability)
C0	(No controller capability)

HP-IB Universal Commands

- DEVICE CLEAR
- SELECTIVE DEVICE CLEAR
- INTERFACE CLEAR
- REMOTE ENABLE
- LOCAL
- LOCAL LOCKOUT

Device Clear and Selective Device Clear (SDC)

These commands are usually sent at the beginning of a program to reset the HP-IB interface of the instrument to a known state without changing the panel settings :

- All buffers flushed
- Stop asserting SRQ
- Service request mask set to ERR (32)
- Clear all errors
- Clear status and key registers
- Ready register RAC bit set

Device Clear using an HP 200 series controller is : CLEAR 7 (Where 7 is the Bus I/O select code).

Selective Device Clear using an HP 200 series controller is : CLEAR 705 (Where 7 is the Bus I/O code and 05 is the device address).

Interface Clear (IFC)

This command clears the HP-IB interface and returns the instrument to the listener idle state; it does not affect the parser or any of the internal buffers of the instrument.

Instrument Clear command using an HP series 200 controller is : ABORT 7
(Where 7 is the Bus I/O select code).

Remote Enable (REN)

The Remote Enable command instructs the instrument to accept instruction via the HP-IB. The instrument will accept commands while in local mode only if they do not change the configuration of the instrument. When the instrument receives the remote enable command, the front panel REMOTE indicator comes on.

It is highly recommended that the instrument be put into the remote with local lockout state (RWLS) when being controlled via the HP-IB. This will disable the front panel LOCAL selection and guarantee that the system controller has sole control of the instrument at all times. To do this the controller should send the REN command followed by the LLO command.

When in RWLS, selecting **OTHER**, **HPIB PORT**, **RETURN TO LOCAL** will cause bit 2 (FPS) of the status byte to be set, generating an SRQ if the SRQ mask is enabled. It is then at the discretion of the controller whether to return the instrument to local-control-or-ignore the request.

Local (LCL)

The instrument can be returned to the local state from the remote state by selecting **OTHER**, **HPIB PORT**, **RETURN TO LOCAL**, or by sending the LCL command from the controller.

Local command using an HP series 200 controller is : LOCAL 705 (Where 7 is the Bus I/O select code and 05 is the device address).

The Local command (LCL) overrides Local Lockout.

Programming Tips

The graphics page is very CPU intensive. If the instrument is operated under remote control while displaying graphs, then these remote control functions may take a considerable time to execute, e.g. 10s for RST.

The hardware may require a settling time after receiving configuration commands. For example, if the instrument is in a production test environment then use can be made of the alarm register to determine when the instrument hardware has fully settled.

When programming the error generator, always allow a settling time for the correct error ratio to appear, comparable to the data rate selected. For example, allow 4 seconds for a 600 baud rate.

It should be noted that users rapidly polling registers during certain instrument functions, such as self-test, auto-setup or printing, can expect these functions to slow significantly in their execution as the remote control interface has a priority response time over these functions. It is recommended that a delay of 100ms always be placed between successive polls.

There are three flags associated with various registers in the instrument which are related to the start/stop testing function. These are the TIP, EOT and OST flags of status register-A and the ready register respectively. The TIP flag behaves as a gate to prevent controllers so programmed from attempting to change instrument configuration. It is set immediately on receipt of a STR command and cleared a short time after receipt of a STP command once all results are calculated and the instrument has settled. The EOT flag is similar in scope to TIP except that it is cleared on receipt of STR and set once the results are available but cleared again when a result is queried.

The OST flag can be thought of as a hardware gate in that it gets set when the instrument counters are actually accumulating results. This usually occurs a short time after receipt of the STR command. The bit is cleared as soon as the instrument counters are no longer accumulating data. Visually:

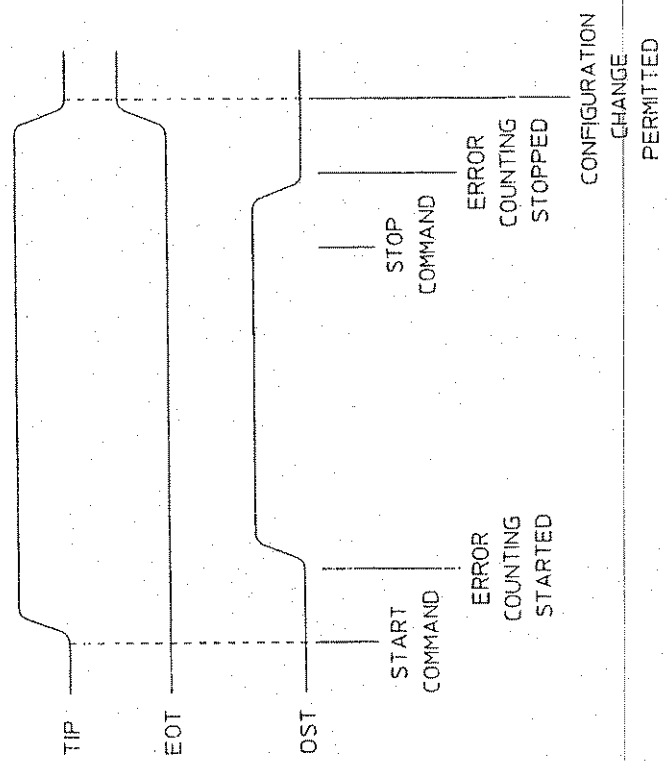

THE COMMANDS

COMMON CAPABILITY MESSAGES

Reset

The reset action message presets the instrument to its default state. A full listing of this default state is given in The Default Conditions part of this chapter. The predefined default state is as follows:

- Configuration defined by stored setting 0
- Stopped testing, self-testing, printing and autoseup
- All buffers flushed
- Stop asserting SRQ (HP-IB version)
- Service request mask set to ERR (HP-IB version)
- Clear all errors
- Clear status, alarm mask and key registers
- Ready register set to RAC, ASC, STC and LQE (not RAC in TERMINAL CONTROL)

The remote control parser and executor are also reset.

RST

Remote

This command causes the instrument to go remote with local lockout. (This is functionally equivalent to the \$REN+\$LLO meta-message used in HP-IB interfaces).

RMT

Local

This command causes the instrument to clear local lockout and return to local. (This is functionally equivalent to the clear \$LLO and \$RTL meta-message used in HP-IB interfaces).

LCL

Clear

This command clears all instrument errors and flushes all buffers without affecting the programmed state of the instrument. (This is functionally equivalent to the \$DCL or \$SDC meta-messages used in HP-IB interfaces). The following things are performed by executing this command:

- All buffers flushed except printer output
- Stop asserting SRQ (HP-IB version)
- Service request mask set to ERR
- Clear all errors
- Clear status, alarm mask and key registers
- Ready register RAC set (not in RS232C terminal control)

The command is as follows:-

CLR

Configuration

This command takes as its parameter a block of data which specifies the instrument's internal setup state. The block is a IEEE Std 728 #H format. This is intended only for restoring an instrument state saved using CON? and hence its internal format is not elaborated upon.

NOTE: This command does not record the settings of remote control sources, or current states of remote control registers. It is equivalent in scope to store/recall stored settings. One block should not be compared with another in a comparison attempt as redundant but variable information is also included in the block.

CON #H where #H = IEEE Std 728 "#H" block of data

The complement of this command is used to enquire about the configuration of the instrument; it returns the configuration of the instrument in exactly the same form, namely the IEEE Std 728 #H data block.

The length of the block will not exceed 2000 characters.

CON? returns #H

Key Query

This command returns the value of the last key pressed on the front panel. The value is returned as an integer whose meaning is given below. If no key was pressed since the last time the command was used, 0 is returned.

Note that this command does not wait until a key is pressed. Using this command clears the key register to 0 and clears FPS in status registers A & B.

- KEY? returns
- 1 = Cursor Up
 - 2 = Cursor Down
 - 3 = Softkey-1
 - 4 = Softkey-2
 - 5 = Softkey-3
 - 6 = Softkey-4
 - 7 = Softkey-5
 - 8 = Settings
 - 9 = Results
 - 10 = Other
 - 11 = Graph
 - 12 = (unused)
 - 13 = Auto Setup
 - 14 = Show History
 - 15 = Key Release
 - 16 = Push To Talk
 - 17 = Volume Lower
 - 18 = Volume Raise
 - 19 = Run/Stop
 - 20 = Print Now
 - 21 = Reset History
 - 22 = Single

n = 1 to 22

Request Service Mask

This command is used to enable or disable the source for setting the RQS bit in status registers A and B. It takes as a parameter a 16-bit integer which is used to mask the various causes for the setting of this bit. Associated with

status register A is a mask which enables or disables the various sources of setting the RQS bit (ie only the positive edge of a bit in status register A with it's corresponding mask bit enabled will cause the RQS bit to be set.) It is this mask which the Request Service command addresses. (In instruments with HP-IB this command sets/clears the sources for SRQ).

RQS n where $n = 0$ to 30719

The mask has an identical bit map as status register A and can be set in three different ways.

1) The parameter can be a single 16 bit integer, corresponding to the addition of binary weighted bits wishing to be enabled, e.g. if we wished to enable EOT and ERR then the command would be:-

RQS 288

2) The parameter can be a list of the binary weighted integers corresponding to all those sources wishing to be enabled separated by commas, e.g. if we wished to enable EOT, FPS and ERR then the command would be:-

RQS 256, 4, 32

3) The parameter can be a list of three letter mnemonics defined in The Status Registers part of this chapter, separated by commas, e.g. if we wished to enable ERR, RDY and LCL then the command would be:-

RQS ERR, RDY, LCL

As well as the three methods of passing the parameter outlined above, any combination may be used, remembering that the result is always evaluated to a 16 bit integer. Care should be taken to ensure the resultant integer is in range and the desired sources are enabled. (Although range checking is done, no checking of constituent parameters is performed to ensure that they are binary values). There are two other special parameters to this command. They are RQS ON and RQS OFF. RQS OFF is not equivalent to RQS 0 because the former disables all reasons for setting the RQS bit (status-A) but remembers the stored mask. Upon receipt of the RQS ON command, service requests will be enabled again with the same mask as before (NOTE any positive edges of sources with their mask set should be caught, so that they will set the RQS bit when the RQS ON command is sent). If the RQS ON command is sent without a corresponding RQS OFF command sent before it, the instrument shall assume the RQS ERR state as a default.

The complement of this command is used to inspect the Service Request Mask. The command responds with a 16 bit integer equivalent to the binary weighted values of those sources which are enabled (outlined in The Status Registers part of this chapter).

RQS? returns n where $n = 0$ to 30719

Instrument Identification

This command programs the identification for the instrument. This is included to be compatible with "common capabilities" and as a standard response. The identification appears on printed output and on the stored measurement page and as a prompt in TERMINAL CONTROL. The string is stored in the instruments EEPROM and will be remembered through power fails and stored settings events. No difference in function can be inferred from the two possible responses, i.e. A HP37732A can have the same functionality as a HP37722A if the accessory is disconnected.

ID n $n = 1$ or HP 37722A
 2 or HP 37732A

The corresponding query command ID? returns HP37722A or HP37732A

Revision Date Query

This command is a request for the instruments firmware revision date and the latest applicable Codes and Formats document (HP728) and Capabilities document to which the instrument was designed. The instrument returns two four digit date codes separated by a comma, these date codes are in standard HP serial number format (a four digit code, where the first two digits indicate the year (from 1960) and the next two indicate the week (01 to 52). The firmware revision date comes first, followed by the Codes and Formats date.

REV? returns *dddd,2332* where *dddd* = Firmware date code.

Serial Number Query

This command is a request for the instrument to return it's individually assigned serial number.

SER? returns *ddddUnnnnn*

Error Code Query

This command is a request to read the instrument's error register. The error register contains an integer in the range -32768 to 32767. The error codes have various meanings, some defined by "common capabilities" and some instrument dependent (see The Error Codes listing at the end of this chapter for a full listing). If no error exists at the time of enquiry, then 0 is returned. The error register is cleared on reading the register or by sending either the CLR or RST command. The error register will also contain the result of a remotely initiated self-test command. This is also cleared as above.

ERR? returns n where $n = -32768$ to 32767

Ready Code Query

This command is a request to read the instrument's ready register. The result is a binary weighted decimal integer. The meanings of the bits is given in the Status Registers part of this chapter.

RDY? returns n where $n = 0$ to 127

Status/Events Query

This command is a request for the instrument to return the contents of status register A. It responds with an integer which represents the 16 bit binary weighted contents of the status register bits. A detailed description of status register A is given in The Status Registers part of this chapter.

STA? returns n where $n = 0$ to 30719

Status Query

This command is a request for the instrument to return the contents of status register B. It responds with an integer which represents the 8 bit binary weighted contents of the status register bits. The act of executing this command also clears the RQS bit in status registers A and B, (similar to the serial poll of HP-IB interfaces). A detailed description of status register B is given in The Status Registers part of this chapter.

STB? returns n where $n = 0$ to 255

Options Query

This command is a request for the instrument to return its options. The result returned is a decimal weighted integer corresponding to the options fitted.

OPT? returns n where $n = 0$ to 111 : Coded as below.

001	001 Timeslot Access
010	002 8Mb/s
100	003 704kb/s

Self-test

The definition of this command is altered for datacom. The self-test command instructs the instrument to perform a selected self-test. Testing runs until completion or stops at the first test to fail. On test completion a subsequent response of 0 to ERR? indicates that the test has passed, any other number indicates a failure, (see service manual for a full list of self-test error codes). Self-test progress can be monitored by polling the STC bit in the ready register.

TST n	$n =$	0 or ALL	All tests
		1 or TEST1	CPU test
		2 or TEST2	Synthesizer test
		3 or TEST3	Asynchronous data test
		4 or TEST4	Interface-test

Accessory Identification Query

This command is a request for the attached accessory to return an identification response.

=ACCID? returns:-

HP15901A: NONE : Datacom lid is present on the accessory interface.
No accessory connected.

Accessory Revision Date Query

This command is a request for the accessory's firmware revision date and the latest applicable Codes and Formats document (HP 728) and Capabilities document to which the instrument was designed. The instrument returns two

four digit date codes separated by a comma, these date codes are in standard Hewlett-Packard serial number format (a four digit code, where the first two digits indicate the year (from 1960) and the next two indicate the week (01 to 52). The firmware revision date comes first, followed by the Codes and Formats date.

=ACCREV? returns:-

ddd,2332

where dddd = Firmware date code

INSTRUMENT SETTINGS COMMANDS

Datacom Interface Type

Selects the datacom electrical interface.

DIF n $n =$ 1 or V24 V.24 interface
 2 or V11TERM V.11 terminated
 3 or V11UNTERM V.11 unterminated
 4 or V35 V.35 interface
 5 or X21 X.21 leased interface

DIF?

Returns:-

n where $n = 1$ to 5

Emulation Type

Selects data terminal or data communication equipment emulation mode.

DEM n $n =$ 1 or DTE Data terminal equipment
 2 or DCE Data communication equipment

DEM?

Returns:-

n where $n = 1$ or 2

Timing Type

Selects the interface timing type. Synchronous involves the use of a clock signal or signals across the interface while asynchronous uses an internally derived timing clock to retime or transmit data. For the X.21 leased interface, only synchronous timing is available.

DTI n $n =$ 1 or ASYNC Asynchronous
 2 or SYNC Synchronous

DTI?

Returns:-

n where $n = 1$ or 2

Asynchronous Character Length

Selects the asynchronous data character length.

CHL n $n =$ 5 or FIVE
 6 or SIX
 7 or SEVEN
 8 or EIGHT

CHL?

Returns:-

n where $n = 5$ to 8

Asynchronous Parity

Selects the asynchronous data parity type.

PAR n	$n =$	1 or ODD	Odd parity
		2 or EVEN	Even parity
		3 or ZEROS	Zeros parity
		4 or ONES	Ones parity
		5 or NONE	No parity

PAR?

Returns:-

n where $n = 1$ to 5

Asynchronous Stop Bits

Selects the number of stop bits for asynchronous data. 1.5 stop bits cannot normally be selected but are forced as a result of a character length of 5-bits.

SBT n $n =$ 1 or ONE 1 stop bit
 2 or TWO 2 stop bits
 3 or ONEP5 1.5 stop bits

SBT?

Returns:-

n where $n = 1$ to 3

Transmit Clock Source

Selects the transmit clock source when in synchronous timing. When the interface is X.21 leased, the source is fixed to INTERFACE with DTE timing and to INTERNAL with DCE timing.

TXC n $n =$ 1 or INTERFACE Looped tx clk
 2 or INTERNAL Internal tx clk

TXC?

Returns:-

n where $n = 1$ or 2

Transmit Clock Source Sense

Selects the transmit clock source sense when the transmitter clock source is INTERFACE.

ICS n $n =$ 1 or POS Positive edge
 2 or NEG Negative edge

ICS?

Returns:-

n where $n = 1$ or 2

Receive Clock Source

Selects the receive clock source when in synchronous timing. When the interface is X.21 leased with DCE timing, the source is fixed to INTERNAL. When the timing is DTE for all interface types, the source is fixed to INTERFACE.

RXC n $n = 1$ or INTERFACE Looped rx clk
 2 or INTERNAL Internal rx clk

RXC?

Returns:-

n where $n = 1$ or 2

Receive Clock Source Sense

Selects the receive clock source sense, this is valid for receiver clock sources INTERFACE and INTERNAL.

CSE n $n = 1$ or POS Positive edge
 2 or NEG Negative edge

CSE?

Returns:-

n where $n = 1$ or 2

Asynchronous Data Rate

Selects the asynchronous data rate for asynchronous timings.

ADR n	$n =$	1 or R19200	19.2kb/s
		2 or R9600	9.6kb/s
		3 or R7200	7.2kb/s
		4 or R4800	4.8kb/s
		5 or R2400	2.4kb/s
		6 or R1800	1.8kb/s
		7 or R1200	1.2kb/s
		8 or R600	600b/s
		9 or R300	300b/s
		10 or R200	200b/s
		11 or R150	150b/s
		12 or R1345	134.5b/s
		13 or R110	110b/s
		14 or R75	75b/s
		15 or R50	50b/s

ADR?

Returns:-

n where $n = 1$ to 15

Synchronous Data Rate

Selects the synchronous data rate for synchronous timing. Note that the highest rates of 1.984Mb/s to 256kb/s are not permitted for the V.24 interface.

SDR n	$n =$	1 or R1984M	1.984Mb/s (not V.24)
		2 or R1024M	1.024Mb/s (not V.24)
		3 or R512K	512kb/s (not V.24)
		4 or R384K	384kb/s (not V.24)
		5 or R256K	256kb/s (not V.24)
		6 or R64K	64kb/s
		7 or R56K	56kb/s
		8 or R48K	48kb/s
		9 or R19200	19.24kb/s
		10 or R14400	14.4kb/s
		11 or R9600	9600b/s
		12 or R4800	4800b/s
		13 or R2400	2400b/s
		14 or R1200	1200b/s
		15 or USER	user program

SDR?

Returns:-

n where $n = 1$ to 15

User Program Synchronous Data Rate

Selects the user defined data rate from 600Hz to 2.048MHz. In V.24 the maximum user defined rate is 128 kHz. For all other interfaces the maximum rate is 2.048MHz. The command parameter can make optional use of the alpha-suffixes "Hz", "kHz" or "MHz" as a multiplier.

URR n n = 600Hz to 10KHz in 10Hz steps
 10KHz to 100KHz in 100Hz steps
 100KHz to 2.048MHz in 1kHz steps

URR?

Returns:-

n where n = 600 to 2048000

Pattern Type

Selects the pattern to be transmitted and received. Pattern FOX is a transmit only pattern available for ASYNC timing only and no receiver measurements are performed when FOX is selected.

DPT n n = 1 or PRBS20 2²⁰-1 PRBS
 2 or BIT63 63-bits
 3 or BIT511 511-bits
 4 or BIT2047 2047-bits
 5 or PRBS15 2¹⁵-1 PRBS
 6 or MARK Permanent mark
 7 or USER 3 to 16 bit user word
 8 or ALT alternating mark/space
 9 or FOX repetitive FOX pattern

DPT?

Returns:-

n where n = 1 to 9

Pattern Polarity

Selects the polarity of the PRBS derived data patterns (DPT 1-5).

POL *n* *n* = 1 or NORMAL Normal polarity
 2 or INVERTED Inverted polarity

POL?

Returns:-

n where *n* = 1 or 2

User Defined Word Pattern

Configures the length and setting for the USER programmable word.

UPP *length*, "*patt*" *length* = 3 to 16 : word length
 "*patt*" = *length* characters 0 or 1

UPP?

Returns:-

length, "*patt*" where *length* = 3 to 16 : word length
 "*patt*" = *length* characters 0 or 1

Display EFS or %EFS Result

This command selects whether the instrument displays EFS or %EFS results. Both results are simultaneously valid and may be accessed via remote control queries.

EFS *n* *n* = 1 or EFS Display EFS result
 2 or PCEFS Display %EFS result

EFS? returns *n* where *n* = 1 or 2

OTHER-PAGE DATACOM SETTINGS

This group of commands correspond to the settings found on the OTHER datacom sub-page. These include Tx and Rx data polarity control, pattern syn control, and fox pattern control.

Transmit Data Polarity

Selects the polarity of the transmit data.

DOP n	$n = 1$ or NORMAL	Normal polarity
	2 or INVERTED	Inverted polarity

DIP?

Returns:-

n where $n = 1$ or 2

Receive Data Polarity

Selects the polarity of the receive data.

DIP n	$n = 1$ or NORMAL	Normal polarity
	2 or INVERTED	Inverted polarity

DIP?

Returns:-

n where $n = 1$ or 2

Transmit Output Clock Sense

Selects the transmitter output clock sense when the interface timing is synchronous.

OCS n	$n = 1$ or POS	Positive clock sense
	2 or NEG	Negative clock sense

OCS?

Returns:-

n where $n = 1$ or 2

Receiver Sync Gain Control

Selects the receiver pattern sync gain resync mode. When sync is lost and NONE is selected the receiver will not attempt to re-sync to the pattern until the manual resync key is pressed on the 15901A lid. If AUTO is selected, the receiver will automatically try and re-sync upon loss of pattern sync. Note that the manual resync key is still available with this selection also.

DSL n	$n =$	1 or NONE	No resync attempted after loss
		2 or AUTO	Resync attempted after loss

DSL?

Returns:-

n where $n = 1$ or 2

Sync Loss AUTO Resync Threshold

Selects the error threshold that must be crossed before pattern synchronization is lost and resync is automatically attempted. This occurs when the receiver sync gain control is AUTO.

ATH n	$n =$	1 or LOW	100 errors in 1000 bits
		2 or MEDIUM	250 errors in 1000 bits
		3 or HIGH	25000 errors in 100000 bits

ATH?

Returns:-

n where $n = 1$ to 3

FOX Character Code

Selects the FOX character code. There are a number of restrictions on this based on the asynchronous character length. These are shown below.

Char Length	FOX Character Code
5	BAUDOT
6	BCDIC,EBCD,IPARS,TRANSCODE
7	ASCII
8	ASCII,EBCDIC

FXC n $n =$ 1 of ASCII
 2 of EBCDIC
 3 of BCDIC
 4 of EBCD
 5 of IPARS
 6 of TRANSCODE
 7 of BAUDOT

FXC?

Returns:-

n where $n = 1$ to 7

FOX Flow Control

Selects the FOX flow control. There are a number of restrictions on this based on the asynchronous character length. These are shown below.

Char Length	FOX Flow Control
5	NONE
6	NONE
7	Xon-Xoff, NONE
8	Xon-Xoff, NONE

FXF n $n =$ 1 or XONXOFF Xon-Xoff flow control
 2 or NONE No flow control

FXF?

Returns:-

n where $n = 1$ or 2

Audio Source (Beep On Error)

This command selects the beep on bit error for the audio output.

AUS n $n = 0$ or OFF Off
 $n = 1$ or ON Beep on bit error

AUS?

Returns:-

n where $n = 0$ or 1

ERROR ADDITION COMMANDS

The following command adds bit errors to the generated data stream.

Error Add Rate

Selects whether the bit error rate is continuous or awaiting a single error add command.

DEU n $n =$ 1 of SINGLE
 2 of EMIN2
 3 of EMIN3
 4 of EMIN4
 5 of EMIN5

DEU?

Returns:-

n where $n = 1$ to 5

Single Error Add

This command injects a single error into the generated output stream provided that the generator has single error add enabled. If not, and error is produced.

This command is equivalent to pressing the front panel **SINGLE ERROR ADD** key.

SEA

TEST PERIOD AND RESULT CONFIGURATION COMMANDS

Block Length

Selects the receiver block length for use in block error measurements. If AUTO is selected and the currently selected pattern is a PRBS then the block length is the PRBS cycle time. Otherwise AUTO selects a block length of $1E+3$.

BLL n	$n = 1$ or AUTO	Automatic block length
	2 or EPLUS3	1000 bits

BLL?

Returns:-

n where $n = 1$ or 2

Test Period Type

Selects the type of test period. MANUAL test periods are controlled from the START/STOP key, SINGLE test periods are started from the START key and will complete in a selected timespan and periods of type BIT will take an amount of time inversely proportionate to the data rate to complete.

DPD n	$n = 1$ or MANUAL	Keyboard control
	2 or SINGLE	Timed duration
	3 or BIT	Bit duration

DPD?

Returns:-

n where $n = 1$ to 3

Single Test Period Duration

Selects the single test period duration.

DTD *period, units* *period* = 1 to 100 Single test period

<i>units</i> = 1	or SECONDS	Units of seconds
2	or MINUTES	Units of minutes
3	or HOURS	Units of hours
4	or DAYS	Units of days

DTD?

Returns:-

period, units where
period = 1 to 100
units = 1 to 4

Bit Test Duration

Selects the bit testing length for test period type BIT.

DBG <i>n</i>	<i>n</i> =	4 or EPLUS4	1E+4 bits
		5 or EPLUS5	1E+5 bits
		6 or EPLUS6	1E+6 bits
		7 or EPLUS7	1E+7 bits
		8 or EPLUS8	1E+8 bits
		9 or EPLUS9	1E+9 bits
		10 or EPLUS10	1E+10 bits

DBG?

Returns:-

4 to 10

CONTROL CIRCUIT TIMING COMMANDS

This group of commands control the configuration of the control circuit timing and control circuits facility as found on the RESULTS page. Control circuit timing is not available for the X.21 leased interface or for FOX patterns or for an asynchronous data rate of 19.2kb/s. Control circuits, however, is always available and the offerings are dependent on the emulation type (DCE/DTE).

Control Circuit Timing Trigger

Selects what event triggers the sweep of the control circuit timing measurement. The measurement itself is initiated by selecting RUN on the softkey offered by the SWEEP field.

TDP n	$n = 1$ or MANUAL	Controlled from softkeys
	2 or SINGLE	Trigger from edge A
	3 or REPEAT	Repeat trigger on edge A

TDP?

Returns:-

n where $n = 1$ to 3

Control Circuit Timing RANGE

Selects the resolution and the range of the control circuit timing diagram.

TRG n	$n = 1$ or ONEHUNDRED	Range is 100ms
	2 or ONE	Range is 1s
	3 or TEN	Range is 10s

TRG?

Returns:-

n where $n = 1$ to 3

Control Circuit Timing DELAY A-B

Selects the A to B line events for the delay measurement of control circuit timing. Delay is measured edge-A to edge-B. For the FIXED choice the events are dependent on the interface selected; for V.24 and V.35 it is RTS/CTS and for V.11 it is RS/CS.

TMM n $n = 1$ or FIXED RTS/CTS or RS/CS
2 or USER User programmable

TMM?

Returns:-

n where $n = 1$ or 2

Control Circuit Timing Delay Edge-A

Selects edge-A for the control circuit timing user program delay and trigger event. Delay measurement is from edge-A to edge-B. The measurement is triggered from edge-A.

TIS n $n =$	1 of RTS or RS	Control line
	2 of CTS or CS	Control line
	3 or DTR or TR	Control line
	4 of DSR or DM	Control line
	5 of DCD or RR or RLSD	Control line
	6 or MON	Control line

TIS?

Returns:-

n where $n = 1$ to 6

Control Circuit Timing Delay Edge-A Sense

Selects the sense (positive or negative going) of delay edge-A. When the sweep is running and the line with this sense is detected then the measurement will trigger.

STE n $n = 1$ or POS Positive going sense
 $n = 2$ or NEG Negative going sense

STE?

Returns:-

n where $n = 1$ or 2

Control Circuit Timing Delay Edge-B

Selects edge-B for the control circuit timing user program delay event. Delay measurement is from edge-A to edge-B. The measurement is triggered from edge-A.

TIE n $n = 1$ or RTS or RS Control line
 $n = 2$ or CTS or CS Control line
 $n = 3$ or DTR or TR Control line
 $n = 4$ or DSR or DM Control line
 $n = 5$ or DCD or RR or RLS Control line
 $n = 6$ or MON Control line

Control Circuit Timing Delay Edge-B Sense

Selects the sense (positive or negative going) of delay edge-B. When the sweep is running and the line with this sense is detected then the measurement will stop.

SPE n $n = 1$ or POS Positive going sense
 $n = 2$ or NEG Negative going sense

SPE?

Returns:-

n where $n = 1$ or 2

Control Circuit Timing Trace Enable

Controls the sweep of the control circuit timing measurement. When RUN is selected and the trigger is MANUAL, the sweep will capture the control line

status for a period determined by the RANGE parameter. If the trigger is either SINGLE ON A or REPEAT ON A then the sweep will not start until the appropriate event A has occurred.

TTR n $n =$ 1 or RUN Sweep enable
 2 or STOP Sweep disable

TTR?

Returns:-

n where $n = 1$ to 2

Control Circuit Timing Status

This query provides information as to the status of a control circuit timing measurement. Its operation is analogous to that of the EOT bit in status registers A and B.

TIA?

Returns:-

n where $n = 0$ or 1

A 0 indicates that the current sweep has not yet completed. A 1 indicates that the current sweep is complete and results may be read.

NOTE: If the trigger is set to REPEAT, then this bit is set at the end of every measurement. It is reset by starting a measurement using the TTR command, by a RST or CLR, by reading any control circuit timing result, or by changing any setting which causes the control circuit display to be cleared.

Control Circuit Timing Line Status

Returns the current status of the control circuit timing lines as a binary weighted integer

CCT?

Returns:-

n where $n = 0$ to 63

DCC3?

Returns:-

n where $n = 1$ or 2

Control DTE RTS/RS/C Circuits

Controls the RTS/RS circuit for DTE interfaces.

DTC1 n $n =$ 1 or ON RTS/RS/C on
2 or OFF RTS/RS/C off

DTC1?

Returns:-

n where $n = 1$ or 2

Control DTE DTR/TR Circuits

Controls the DTR/TR circuit for DTE interfaces.

DTC2 n $n =$ 1 or ON DTR/TR on
2 or OFF DTR/TR off

DTC2?

Returns:-

n where $n = 1$ or 2

RESULT QUERY COMMANDS

This section contains all measurement result query commands. If these commands are executed outside testing, the last test period results are returned; during testing the results returned are the current results.

Some results are not always available, therefore they return not only the result but a validity flag. In addition, a second flag *oor* (out-of-range) will indicate whether the result is underrange (0), inrange (1) or overrange (2).

NOTE: The commands in this section have the effect of clearing the EOT bit in Status Registers A and B.

Basic Results Query

This requests one of the basic bit or block error results. The format of the result returned will depend on the selected result. Basic results are not available for pattern FOX. Clock slip results are valid only with PRBS type patterns.

RLR? n	n = 1 or EC	Error Count
	2 or BC	Block Count
	3 or BER	Bit Error Rate
	4 or BLER	Block Error Rate
	5 or PCEFS	% Error Free Seconds
	6 or ES	Errored Seconds
	7 or BLE	Block Error Count
	8 or CLK	Clock Slips
	9 or EFS	Error Free Seconds

Returns:-

<i>flag, oor, n</i>	<i>flag</i> = 0 or 1	Validity Flag
	<i>oor</i> = 1	Inrange
	n = 0 to 999999	EC,BC,ES,BLE,CLK,EFS
	n = 1.000E+6 to 9.99E+99	< 1,000,000,000
	n = 0 to 1.0E+00	≥ 1,000,000,000
	0.00 to 100.00	BER,BLER
		PCEFS

Bit Analysis Results Query

This requests one of the bit analysis results. The format of the result returned will depend on the selected result. Bit analysis results are not available for ASYNC timing or for bit test durations of type BIT or for the FOX pattern.

RAR? n	n = 1 or PCDM	% Degraded minutes
	2 or PCAV	% Availability
	3 or PCSES	% Severely errored seconds
	4 or PCES	% Errored seconds
	5 or DM	Degraded minutes
	6 or SES	Severely errored seconds
	7 or ESG821	Errored seconds
	8 or UAS	Unavailable seconds

Returns:-

flag,oor,n	flag = 0 or 1	Validity Flag
	oor = 1	Inrange
	n = 0 to 999999	DM,SES,ESG821,UAS <1000000
	n = 1.000E+6 to 9.99E+99	DM,SES,ESG821,UAS ≥1000000
	n = 0.0 to 1.00+00	PCDM,PCAV,PCSES

Alarm Seconds Results Query

Returns the total number of seconds for which a particular alarm has been present in the current or previous test period.

RAL? n	n = 1 or DATALOSS	Data loss
	2 or PATLOSS	Pattern loss
	3 or CLKSLIP	Clock slip seconds
	4 or PWRLOSS	Power loss

Returns:-

flag,oor,n	flag = 0 or 1	Validity Flag
	oor = 1	Inrange
	n = 0 to 999999999	Result

Frequency Results Query

Returns the frequency results in Hertz for either the transmit or receive interface. This result is always available and does not require the instrument test period to be started.

Note that the frequency result remains valid even if no signal is present. Under this circumstance the count will be zero.

FRQ? *n* *n* = 1 or TXFREQ Transmit frequency
 2 or RXFREQ Receive frequency

Returns:-

flag,oor,n *flag* = 0 or 1 Validity Flag
 $oor = 1$ Inrange
 n = 0 to 999999 Result

Delay Measurement Query

Returns the control circuit timing delay result. This measurement is initiated by the SWEEP control on the control circuit timing page. This will reset the sweep completed bit obtained by TTA?

DEL?

Returns:-

flag,oor,n *flag* = 0 or 1 Validity Flag
 $oor = 1$ Inrange
 n = 0 to 99.999 Result in seconds (10s range)
 n = 0 to 9999.9 Result in milliseconds (1s/100ms range)

Elapsed Bit Result Query

Returns the number of elapsed bits in the current or last testing period. This result is always available in timed and bit test types.

N.B. Elapsed time (ELP?) is always available also.

ELB?

Returns:-

$Flag, n$ $Flag = 0$ or 1 Validity Flag
 $n = 0$ to 999999 Count < 1000000
 $n = 1.000E+6$ to $9.999E+9$ Count ≥ 1000000

Control Circuit Timing Data

Returns the binary state and change data representing the control circuit timing diagram. The data is returned as a list of n binary weighted integers; each word contains both state and change information as detailed in the table. If the data is currently invalid then n will be returned as 0, if it is valid then $n = 101$, followed by 100 entries m of status information. This will reset the sweep completed bit obtained by TIA?.

RTD?

Returns:-

n
 $[m1]$
 $[m2]$

 $[mn]$

The information bits m have the following significance:

DB7	DB6	DB5	DB4	DB3	DB2	DB1	DB0
CH1	CH0	ST5	ST4	ST3	ST2	ST1	ST0

DB15	DB14	DB13	DB12	DB11	DB10	DB9	DB8
0	0	0	0	CH5	CH4	CH3	CH2

Bit 0 ST0 :	This bit indicates the state of the RTS/RS sampled control line.
Bit 1 ST1 :	This bit indicates the state of the CTS/CS sampled control line.
Bit 1 ST2 :	This bit indicates the state of the DTR/DR sampled control line.
Bit 1 ST3 :	This bit indicates the state of the DSR/DM sampled control line.
Bit 1 ST4 :	This bit indicates the state of the DCD/RR/RLSD sampled control line.
Bit 1 ST5 :	This bit indicates the state of the MON sampled control line. This will always be 0 if the interface is V.11 or V.35.
Bit 1 CH0 :	This bit indicates that a glitch was present on the RTS/RS sampled control line.
Bit 1 CH1 :	This bit indicates that a glitch was present on the CTS/CS sampled control line.
Bit 1 CH2 :	This bit indicates that a glitch was present on the DTR/DR sampled control line.
Bit 1 CH3 :	This bit indicates that a glitch was present on the DSR/DM sampled control line.
Bit 1 CH4 :	This bit indicates that a glitch was present on the DCD/RR/RLSD sampled control line.
Bit 1 CH5 :	This bit indicates that a glitch was present on the MON sampled control line. This will always be 0 if the interface is V.11 or V.35.

A "glitch" means that a transition was detected between the sampling points, but the state of the line at the sampled points remained the same.

Control Circuit Timing Compressed Data Query

Returns the binary state and change data representing the timing diagram in a compressed format. It is in effect the same data as in the RTD? command but duplicated lines are compressed onto one line with a *repeat_count* before the information integer *m*. If the data is currently invalid then *n* will be returned as 0, if it is valid then $n \leq 101$, followed by *n-1* entries of repeat count and status information. This will reset the sweep completed bit obtained by TTA?.

RTZ?

Returns:-

n
[repeat_count-1, m1]
[repeat_count-2, m2]
|
[repeat_count-n, mn]

STORED MEASUREMENT AND GRAPHICS QUERY COMMANDS

The following commands are only available outwith a test period. They access stored measurement information from previously run tests. In the case of stored measurement result query commands, the commands are broadly similar to those listed in the RESULT QUERY COMMAND section with the addition of a first parameter pointing to the store in question. (This parameter should have value "0" to access the "LAST" measurement store.)

These commands do not affect any status registers unlike their RESULT QUERY COMMAND counterparts.

Stored Graphical Data Query

This command has a modified response for datacom stores and returns store sample data as a series of records, one for each sample for store n . (A sample can be either for a 1, 15 or 60 minute period). This could return as much as 6000 lines of information.

SMD? n n = -9 to 0 Store number

Returns:-

$g1$ -data, $g2$ -data, $g3$ -data, $g4$ -data, $g5$ -
data, "alarm-bits", $g1$ -data, $g2$ -data, $g3$ -data, $g4$ -
data, $g5$ -data, "alarm-bits", $g1$ -data, $g2$ -data, $g3$ -
data, $g4$ -data, $g5$ -data, "alarm-bits" |

EOI

$g1$ -data =	XE+Y	Bit error count in sample
$g2$ -data =	XE+Y	Block error count in sample
$g3$ -data =	XE+Y	Unused
$g4$ -data =	XE+Y	Unused
$g5$ -data =	XE+Y	Unused
"alarm-bits" =	8 characters 1 or 0	Alarms for that sample

NOTE: From left to right the alarms are Power Loss, Data Loss, Pattern Loss and Clock Slip seconds, a "1" indicating that the alarm was present. The four least significant bits are unused.

An example of returned data for an 8 sample period is:

```

0E+0, 0E+0, 0E+0, 0E+0, 0E+0, 0E+0, 0E+0, 0E+0, "000000000"
1E+0, 0E+0, 0E+0, 0E+0, 0E+0, 0E+0, 0E+0, 0E+0, "000000000"
4E+1, 5E+2, 0E+0, 0E+0, 0E+0, 0E+0, 0E+0, 0E+0, "000100000"
0E+0, 0E+0, 0E+0, 0E+0, 0E+0, 0E+0, 0E+0, 0E+0, "000000000"
0E+0, 0E+0, 0E+0, 0E+0, 0E+0, 0E+0, 0E+0, 0E+0, "000000000"
8E+8, 5E+5, 0E+0, 0E+0, 0E+0, 0E+0, 0E+0, 0E+0, "011000000"
0E+0, 0E+0, 0E+0, 0E+0, 0E+0, 0E+0, 0E+0, 0E+0, "000000000"
0E+0, 0E+0, 0E+0, 0E+0, 0E+0, 0E+0, 0E+0, 0E+0, "000000000"
EOI

```

Stored Graphical Data in Compressed Form Query

This command has a modified response for datacom stores and returns store sample data for the specified store in a more compressed form than that of the SMD? command. Each output line is prepended by an integer repeat counter. Since for live data a lot of the samples will be zero, the data size will be very much compressed. It is up to the controller to interpret the data back to its uncompressed form.

SMZ? n n = -9 to 0 Store number

Returns:-

```

n1,g1-data,g2-data,g3-data,g4-data,g5-
data,"alarm-bits" n2,g1-data,g2-data,g3-
data,g4-data,g5-data,"alarm-bits" n3,g1-
data,g2-data,g3-data,g4-data,g5-data,"alarm-
bits" |

```

EOI

$n1, n2 = 1$ to 6000 Number of repeated results
 $g1\text{-}data = XE+Y$ Bit error count in sample
 $g2\text{-}data = XE+Y$ Block error count in sample
 $g3\text{-}data = XE+Y$ Unused
 $g4\text{-}data = XE+Y$ Unused
 $g5\text{-}data = XE+Y$ Unused
 "alarm-bits" = 8 characters 1 or 0 Alarms for that sample

NOTE: From left to right the alarms are Power Loss, Data Loss, Pattern Loss and Clock Slip seconds, a "1" indicating that the alarm was present. The four least significant bits are unused.

An example of returned data for SMD? is shown below.

```

1, 0E+0, 0E+0, 0E+0, 0E+0, 0E+0, "000000000"
1, 1E+0, 0E+0, 0E+0, 0E+0, 0E+0, "000000000"
1, 4E+1, 5E+2, 0E+0, 0E+0, 0E+0, "000100000"
2, 0E+0, 0E+0, 0E+0, 0E+0, 0E+0, "000000000"
1, 8E+8, 5E+5, 0E+0, 0E+0, 0E+0, "011000000"
2, 0E+0, 0E+0, 0E+0, 0E+0, 0E+0, "000000000"
E01
  
```

Stored Telecom/Datacom Mode

This queries whether a particular store holds telecom or datacom result information. The response is as per MODE?.

SMD? n $n = -9$ to 0 Store number

Returns:-

n where $n = 1$ or 2 1 - Datacom, 2 - Telecom

Stored Interface Type

This queries the interface type for a particular store. The response is as per DIF?.

SDIF? n $n = -9$ to 0 Store number

Returns:-

n where $n = 1$ to 5

Stored Emulation Type

This queries the emulation type for a particular store. The response is as per DEM?.

SDEM? n $n = -9$ to 0 Store number

Returns:-

n where $n = 1$ or 2

Stored Timing Type

This queries the timing type for a particular store. The response is as per DTI?.

SDTI? n $n = -9$ to 0 Store number

Returns:-

n where $n = 1$ or 2

Stored Asynchronous Character Length

This queries the asynchronous data character length for a particular store. The response is as per CHL?.

SCHL? n $n = -9$ to 0 Store number

Returns:-

n where $n = 1$ to 4

Stored Asynchronous Parity

This queries the asynchronous data parity setting for a particular store. The response is as per PAR?

SPAR? n $n = -9$ to 0 Store number

Returns:-

n where $n = 1$ to 5

Stored Asynchronous Stop Bits

This queries the number of stop bits for asynchronous data for a particular store. The response is as per SBT?

SBT? n $n = -9$ to 0 Store number

Returns:-

n where $n = 1$ to 3

Stored Transmit Clock Source

This queries the transmit clock source for a particular store. The response is as per TXC?

STXC? n $n = -9$ to 0 Store number

Returns:-

n where $n = 1$ or 2

Stored Receive Clock Source

This queries the receive clock source for a particular store. The response is as per RXC?

SRXC? n $n = -9$ to 0 Store number

Returns:-

n where $n = 1$ or 2

Stored Asynchronous Data Rate

This queries the asynchronous data rate for a particular store. The response is as per ADDR?.

SADR? n $n = -9$ to 0 Store number

Returns:-

n where $n = 1$ to 15

Stored Synchronous Data Rate

This queries the synchronous data rate for a particular store. The response is as per SDR?.

SSDR? n $n = -9$ to 0 Store number

Returns:-

n where $n = 1$ to 15

Stored User Program Synchronous Data Rate

This queries the user program synchronous data rate for a particular store. The response is as per URR?.

SURR? n $n = -9$ to 0 Store number

Returns:-

n where $n = 600$ to 2048000

Stored Pattern Type

This queries the pattern type for a particular store. The response is as per DPT?

SDPT? n $n = -9$ to 0 Store number

Returns:-

n where $n = 1$ to 9

Stored User Defined Word Pattern

This queries user word pattern for a particular store. The response is as per UPP?

SUPP? n $n = -9$ to 0 Store number

Returns:-

$length$, "patt" where $length = 3$ to 16
"patt" = "length" characters 0 or 1

Stored Pattern Polarity

This queries the PRBS pattern polarity for a particular store. The response is as per POL?

SPOL? n $n = -9$ to 0 Store number

Returns:-

n where $n = 1$ or 2

Stored Transmit Data Polarity

This queries the transmit data polarity for a particular store. The response is as per DOP?

SDOP? n $n = -9$ to 0 Store number

Returns:-

n where $n = 1$ or 2

Stored Receive Data Polarity

This queries the receive data polarity for a particular store. The response is as per DIP?.

SDIP? n $n = -9$ to 0 Store number

Returns:-

n where $n = 1$ or 2

Stored Block Length

This queries the receiver block length for a particular store. The response is as per BLL?.

SBL? n $n = -9$ to 0 Store number

Returns:-

n where $n = 1$ or 2

Stored Receiver Sync Gain Control

This queries the receiver pattern sync gain control for a particular store. The response is as per DSL?.

SDSL? n $n = -9$ to 0 Store number

Returns:-

n where $n = 1$ or 2

Stored Sync Loss AUTO Resync Threshold

This queries the receiver pattern sync loss resync threshold for a particular store. The response is as per ATH?

SATH? *n* *n* = -9 to 0 Store number

Returns:-

n where *n* = 1 to 3

Stored Basic Results Query

This queries the basic results for a particular store. The response is as per RLR?.

SRLR? *n,b* *n* = -9 to 0 Store number

<i>b</i> = 1 or EC	Error Count
2 or BC	Block Count
3 or BER	Bit Error Rate
4 or BLER	Block Error Rate
5 or PCEFS	% Error Free Seconds
6 or ES	Errored Seconds
7 or BLE	Block Error Count
8 or CLK	Clock Slips
9 or EFS	Error Free Seconds

Returns:-

<i>flag, oor, n</i>	<i>flag</i> = 0 or 1	Validity Flag
	<i>oor</i> = 1	Inrange
	<i>n</i> = 0 to 999999	EC, BC, ES, BLE, CLK, EFS
	<i>n</i> = 1.000E+6 to 9.99E+99	< 1000000
	<i>n</i> = 0 to 1.0E+00	EC, BC, ES, BLE, CLK, EFS
	0.00 to 100.00	≥ 1000000
		BER, BLER
		PCEFS,

Stored Bit Analysis Results Query

This queries the bit analysis results for a particular store. The response is as per RAR?.

SRAR? *n, b* *n* = -9 to 0 Store number

b = 1 or PCDM % Degraded minutes
2 or PCAV % Availability
3 or PCSES % Severely errored seconds
4 or DM % Errored seconds
5 or SES Degraded minutes
6 or ESG821 Severely errored seconds
7 or UAS Errored seconds
Unavailable seconds

Returns:-

flag, cor, n *flag* = 0 or 1 Validity Flag
oor = 1 Inrange
n = 0 to 999999 DM, SES, ESG821, UAS < 1,000,000,000
n = 1.000E+6 to 9.99E+99 DM, SES, ESG821, UAS ≥ 1,000,000,000
n = 0.0 to 100.00 PCDM, PCAV, PCSES

Stored Alarm Seconds Results Query

This queries the alarm seconds results for a particular store. The response is as per RAL?.

SRAR? *n, b* *n* = -9 to 0 Store number

b = 1 or DATALOSS Data loss
2 or PATLOSS Pattern loss
3 or CLKSLIP Clock slip seconds
4 or PWRLOSS Power loss seconds

Returns:-

<i>flag, oor, n</i>	<i>flag = 0 or 1</i>	Validity Flag
	<i>oor = 1</i>	Inrange
	<i>n = 0 to 999999999</i>	Result

Stored Elapsed Bits

This queries the elapsed bits for a particular store. The response is as per ELB?.

SELB? *n* *n* = -9 to 0 Store number

Returns:-

<i>flag, n</i>	<i>flag = 0 or 1</i>	Validity Flag
	<i>n = 0 to 999999</i>	Count < 1000000
	<i>n = 1.000E+6 to 9.999E+99</i>	Count ≥ 1000000

KEYBOARD FUNCTION COMMANDS

Telecom/Datacom Mode

This command swaps the operation of the instrument to be either telecom or datacom and equates to the corresponding key on the datacom lid. Each mode is exclusive of the other in that telecom tests and configurations are not permitted when in datacom operation and vice-versa.

NOTE: This command causes the instrument to be completely reconfigured. During this reconfiguration any remote control commands sent to the instrument will be ignored, and afterwards the instrument will be LOCAL.

MODE n $n =$ 1 or DATACOM
 2 or TELECOM

MODE?

Returns:-

n where $n =$ 1 or 2

Manual Resync

This command equates to pressing the MANUAL RESYNC key on the datacom lid. It can be sent freely at any time.

MAN

Error Codes

Within this chapter are listed all error codes for the instrument, including the datacom module. They are all accessed by the ERR? command.

Print Now

This command causes the instrument to produce a printout (on demand). The output will be returned to the controller as a common port is used for controlling and printing. This command is equivalent to pressing the front panel print now key.

REML0G

Common Capability Errors

The error codes that appear under this section are the recommended error numbers as defined in the document Reserved HP-IB commands, Recommended Practice for Common Capabilities. They are divided into three sections, although there may be a few instrument dependent error codes appearing under these sections also.

These are indicated by an asterisk.

Parse Time Errors (Error codes -100 to -199)

The errors listed here occur during the parsing of HP-IB commands.

-100	Command error (Unknown command)
-101	Invalid character received
-110	Command header error
-111	Header delimiter error
-120	Numeric argument error
-121	Wrong data type (Numeric expected)
-122	Precision error; rounding occurred
-123	Numeric overflow
-129	Missing numeric argument
-130	Non numeric argument error (mnemonic not recognized)
-131	Wrong data type (char expected)
-132	Wrong data type (string expected)
-133	Wrong data type (block type #A required)
-134	Data overflow : string or block too long
-135	Error in #H block

-139	Missing non numeric argument
-141	Command buffer overflow
-142	Too many arguments
-143	Argument delimiter error
-144	Invalid message unit delimiter
-150	Unexpected EOI
-151	CR found without following LF
-160*	RS232 Parity Error
-161*	RS232 Framing Error
-162*	RS232 UART Overrun Error
-163*	RS232 Internal Input Buffer Overrun Error

* = Instrument dependent error code.

Execution Time Errors (Error codes -200 to -299)

These errors are caused at execution time of remote control commands.

-200	No can do (generic execute error)
-201	Not executable in local mode
-202	Settings lost due to RTL or PON
-203	Trigger ignored
-211	Legal command, but settings conflict
-212	Argument out of range
-221	Busy doing something else
-222	Insufficient capability or configuration
-231	Input buffer full or overflow
-232	Output buffer full or overflow
-240	Command provided through meta message only (HP-IB only)
-241	Command not implemented
-243	Command not executable while remote
-250	Command illegal during testing
-251	Command illegal when not testing
-252	Commands in incorrect sequence
-260	Reserved

Stored Measurement Results and Graphics Errors (Error codes -410 to -499)

-410	Not allowed while SMG running
-411	Requested SMG store out of range
-412	Requested SMG store unused - no data
-413	Requested SMG text result out of range

Option or Capability Errors (Error codes -600 to -699)

The error codes in this section are issued if a legal command is received, but it cannot be executed due to insufficient capability or unsuitable option configuration. They are all diagnosed by the remote control parser or executor.

600*	Instrument has no timeslot access option fitted
601*	Instrument has no 704kb/s interfaces fitted
602*	Instrument has no 8Mb/s interfaces fitted
603*	Instrument has no HP-IB interface fitted
604*	Not running under battery power
605*	Command not permitted in datacom operation
606*	Command not permitted in telecom operation
607*	Instrument has no accessory fitted
608*	Command only permitted in RS232C operation
609*	Command only permitted in HP-IB operation
610*	Command not permitted while control circuit sweep not running
611*	Command not permitted while control circuit sweep running
612*	Accessory fault detected

* = Instrument dependent error code.

Self-Test Errors (Error codes 700 to 1599)

There is only one self-test error, which indicates that the instrument has failed one of the tests specified in the TST command. No errors are reported by the power-on tests. Test failure is indicated by a fail code. Fail codes are grouped to indicate the test which has failed. More detailed information is supplied in the service documentation.

Status Registers

STATUS REGISTER A

This register is accessed by the STA? command and contains a 16 bit word describing the instrument's status. Nine of the sixteen bits are defined by the document *HP practice for common capabilities* of 8 August 1983, while the other seven are instrument dependent (indicated below). Each bit is a latched record of an event (not an instantaneous reading). The cause of setting and method of clearing is described below:-

DB15	DB14	DB13	DB12	DB11	DB10	DB9	DB8
0	SMG	DAT	TIP	0	0	ALC	EOT

DB7	DB6	DB5	DB4	DB3	DB2	DB1	DB0
MSG	RQS	ERR	RDY	LCL	FPS	PWR	RQC

Bit 0 RQC : For compatibility with "common capabilities". Not used in this instrument - always reads as 0.

Bit 1 PWR : For compatibility with "common capabilities". The instrument is about to power down or the battery (where fitted) is in a low state of charge.

Bit 2 FPS : Front panel service request. A front panel key has been pressed. Cleared by KEY?, RST or CLR or the meta messages \$DCL, \$SDC (HP-IB) or (break) (RS232C).

Bit 3 LCL : Local operation. This is set when the power has been cycled. Cleared by STA?, STB?, CLR or RST or the meta messages \$DCL, \$SDC (HP-IB) or (break) (RS232C).

Bit 4 RDY : This bit is a direct reflection of the DRO bit (bit-3) of the ready register. (See RDY? and the ready register).

- Bit 5 ERR : Error. A remote control or self-test error of some description has occurred (see ERR? command and The Error Code listing at the end of this chapter for further information). Cleared by ERR?, CLR or RST or the meta messages \$DCL, \$SDC (HP-IB) or (break) (RS232C). Some errors, such as ROM checksum, will not go away until the ROM is changed.
- Bit 6 RQS : Service requested. This bit is primarily intended for instruments fitted with HP-IB and is set if an SRQ is generated. In instruments running under RS232C remote control the bit will still behave as described under the RQS command. Cleared by STB?, RST, CLR or the meta messages \$DCL, \$SDC and serial poll (HP-IB) or (break) (RS232C).
- Bit 7 MSG : For compatibility with "common capabilities". There is an ASCII string in the display area or the instrument has something to say.
- Not used in this instrument - always reads as 0.
- Bit 8 *EOT : End of testing. This bit is set when the instrument reaches the end of its test period, whether it be manual or single. NOTE: There may be a delay of up to 200ms between the actual end of the test period and this bit being set. Cleared at the start of any test period by STR or by RST, CLR or the meta messages \$DCL, \$SDC (HP-IB) or (break) (RS232C) or any query command requesting measurement results. This bit can be used to determine when it is safe to send configuration commands which may be locked out due to testing.
- Bit 9 *ALC : Alarm change. This is set when any of the alarms in the alarm status register change and the corresponding bit in the alarm mask register is enabled, (see ALM? and AMR). Cleared by ALM?, RST or CLR or the meta messages \$DCL, \$SDC (HP-IB) or (break) (RS232C).
- Bit 12 *TIP : Test in progress. This bit is set on receipt of a STR command to indicate that the instrument has started testing and no further configuration commands will be accepted. There may be a delay of up to 200ms between this bit being set and the actual start of testing. (The ready register OST bit can be used to determine when the instruments counters are actually counting). Cleared at the end of any test period by STP or by RST. This bit can be used to determine when it is safe to send configuration commands and when end of test results are available.

- Bit 13 *DAT : Datacom application. This bit is set if, when the datacom lid option is fitted, the instrument is in datacom application mode.
- Bit 14 *SMG : Busy downloading information into its internal SMG store. Stored measurement information can only be accessed when this bit is clear.
- Bit 15 0 : Zero. This is included to be compatible with "common capabilities" and is used to ensure a positive number for STA? response in 16 bit computers.

* = Instrument dependent status bits

Each of the bits in this register (excluding bit 6) can give rise to a change of state of bit 6 (RQS) and hence in the case of instruments with HP-IB capability, can generate an SRQ dependent upon the state of the SRQ mask setting. The RQS command is used to set the SRQ mask which has bits identical to that in status register A. An SRQ, and hence a change of state of the RQS bit, is generated on the positive edge of any bit in status register A if the corresponding bit in the SRQ mask is set. If this function is disabled by the RQS OFF command, any positive transition of a source with its mask bit enabled will be caught and SRQ'd when the RQS ON command is sent.

STATUS REGISTER B

This register is accessed by the STB? command (or a serial poll in the case of HP-IB) and contains an 8 bit word describing the important instrument status information. Each bit is a latched record of an event (not an instantaneous reading). The causes of setting and method of clearing are described below:-

DB7	DB6	DB5	DB4	DB3	DB2	DB1	DB0
0	RQS	ERR	RDY	LCL	FPS	ALC	EOT

Bit 0 *EOT :

End of testing. This bit is set when the instrument reaches the end of its test period, whether it be manual or single. NOTE: There may be a delay of up to 200ms between the actual end of the test period and this bit being set. Cleared at the start of any test period by STR or by RST, CLR or the meta messages \$DCL, \$SDC (HP-IB) or (break) (RS232C) or any query command requesting measurement results. This bit can be used to determine when it is safe to send configuration commands which may be locked out due to testing.

Bit 1 ALC :

Alarm change. This is set when any of the alarms in the alarm status register change and the corresponding bit in the alarm mask register is enabled, (see ALM? and AMR). Cleared by ALM?, RST or CLR or the meta messages \$DCL, \$SDC (HP-IB) or (break) (RS232C).

Bit 2 FPS :

Front panel service request. A front panel key has been pressed. Cleared by KEY?, RST or CLR or the meta messages \$DCL, \$SDC (HP-IB) or (break) (RS232C).

Bit 3 LCL :

Local operation. This is set when the power has been cycled. Cleared by STA?, STB?, CLR or RST or the meta messages \$DCL, \$SDC (HP-IB) or (break) (RS232C).

Bit 4 RDY :

This bit is a direct reflection of the DRO bit (bit-3) of the ready register. (See RDY? and the ready register).

Bit 5 ERR :

Error. A remote control or self-test error of some description has occurred (see ERR? command and The Error Code listing for further information). Cleared by ERR?, CLR or RST or the meta messages \$DCL, \$SDC (HP-IB) or (break) (RS232C). Some errors, such as ROM checksum, will not go away until the ROM is changed.

Bit 6 RQS :

Service requested. This bit is primarily intended for instruments fitted with HP-IB and is set if an SRQ is generated. In instruments running under RS232C remote control the bit will still behave as described under the RQS command. Cleared by STB?, RST, CLR or the meta messages \$DCL, \$SDC and serial poll (HP-IB) or (break) (RS232C). Cleared by STB?, RST or CLR.

READY REGISTER

This register is accessed using the RDY? command. The ready register is a byte with binary weighted bits assigned as follows:-

DB7	DB6	DB5	DB4	DB3	DB2	DB1	DB0
0	LQE	STC	ASC	DRO	AOC	OST	RAC

Bit 0 RAC : Ready to accept new command. This bit is included for common capabilities and is not used in this instrument. This bit will always appear set.

Bit 1 OST : Operation started, this bit is set when the instrument starts testing and reset when it has stopped. The flag reflects the actual start of measurement timing but it is not an indication of when results are available or when configuration commands are permitted, (see status-A EOT, TIP flags and Programming Tips section).

Bit 2 AOC : All operations complete. This bit is included for common capabilities and is not used in this instrument. This bit will always appear clear.

Bit 3 DRO : Data ready for output. This bit is set while a command is outputting data on reply to a query command and is included for common capabilities but has no real use in this instrument. However, the RDY-bit in status registers A and B directly follow this bit and a positive transition of the former will generate an SRQ (HP-IB) and change of state of status A RQS bit if its mask is enabled. On reads of these registers this bit will always appear set.

Bit 4 ASC : Auto-setup complete. This bit is cleared following a request for auto-setup, and set on completion of that setup. Not available in Datacom operation.

Bit 5 STC : Self-Test complete. This bit is cleared following a request for self test, and set on test complete.

Bit 6 LQE : Logging (Printer) Queue Empty. This bit is clear while there is data present in the instruments internal printer output buffer and set when this buffer is empty. NOTE: No account is taken of buffering within an external printing device.

ALARM REGISTER

This register is accessed by the ALM? command. The format shown below for the alarm register also applies to the alarm change register and the alarm mask register. Alarm history is not available in Datacom mode. A "1" in a bit position indicates that the specified condition is prevailing. If a given alarm condition changes and the corresponding bit in the alarm mask register (see AMR) is a "1", then the alarm change (ALC) bit will be set in Status Registers A & B. Note that for instruments fitted with and under HP-IB control this may generate an SRQ (and set status A RQS) if the ALC bit in the RQS mask register (see RQS) is a "1". The execution of this command clears the ALC bits in status registers A and B.

DB15	DB14	DB13	DB12	DB11	DB10	DB9	DB8
0	0	0	0	UAV	PWL	0	0

DB7	DB6	DB5	DB4	DB3	DB2	DB1	DB0
0	ERR	PAT	0	0	0	0	SGL

Bit 0 SGL : Signal loss. Set when no signal is present at the selected input port.

Bit 5 PAT : Pattern loss. Set when datacom pattern sync loss occurs. Clear outwith this criterion.

Bit 6 ERR : Errors detected. Set if any bit errors has occurred in the last 100ms.

Bit 10 PWL : Power loss. This history flag is set if the power has failed during the last or current test period. Cleared at the start of the next test period.

Bit 11 UAV : Unavailability. This flag is set during testing if the system under test is deemed unavailable. The system under test is deemed available at the start of testing and the flag remains as history at the end of testing.

Notes:

- (a) UAV bit only changes during test periods, it has no meaning otherwise other than as a measurement result during and after testing.
- (b) Bits 0-9 are direct reflections of the corresponding front panel leds where fitted.
- (c) The PWL bit will be set if power fails during a test interval. It will be reset upon starting of the next test.

Default Conditions

The following settings are used by the instrument following backup RAM failure. The RST command and RCL 0 command reset the instrument to these conditions.

System: (Unaffected by RCL 0)

SRQ mask register	ERR
Status Registers A and B	LCL*, RDY
Ready Register	RAC, ASC, STC, LQE
Error register	0
Alarm mask register	0
Key register	0

Transceiver Settings:

Interface	V.24
Emulate	DTE
Timing	ASYNC
Tx Clock Source	Interface (positive edge)
Rx Clock Source	Interface (negative edge)
ASYNC Character Length	7-bits
ASYNC Parity	Odd
ASYNC Stop Bits	1
Tx Data Rate	9600b/s
(ASYNC/SYNC)	
Tx Data Rate	128kb/s

(/SYNC user prog)	
Tx Output Clock Sense	Positive Edge
Pattern	2-20-1 (normal)
Block Length	AUTO
Error Add	Single

Other Settings:

Tx Data Polarity	Normal
Rx Data Polarity	Normal
FOX Character Code	ASCII
FOX Flow Control	None

Results Control:

Display Basic Results
 Test Period Manual
 Single Period Duration 10s
 Bit Period Duration 1E4 Bits
 Storage Off

Control Circuits:

Trigger Manual
 Range 100ms
 Delay A-B Fixed
 Edge-A (user) positive edge
 Edge-B (user) negative edge
 Sweep Stopped
 Circuit RTS/CS/etc Control Off

RS232 Port:**

RS232 COMPUTER CONTROL
 Connection HARDWIRED
 Xon/Xoff RX & TX
 Enq/Ack OFF
 Speed 9600bd
 Parity ODD
 Stop Bits 1
 (HP-IB Address) 5)

Printer**:

Protocol XON-XOFF
 Speed OFF
 Stop bits 9600bd
 Print Style 1
 Compress Compress

Other Functions:

Stored Setting Number 0
 Stored Setting Lock ON
 Deselected Timeslots PRBS 2 6-1
 Beep On Error OFF
 Keyboard Lock OFF
 Real Time Clock Mode RUN
 Self-test Function ALL

* This default only after power on.

** These settings unaffected by RST or RCL 0 but are set to these values following non-volatile memory failure.

Synchronous Clock Configurations

The Datacom Analyzers can use various clock configurations when emulating a DTE or DCE.

The examples shown in the illustrations apply to the V.24, V.11 and V.35 interfaces, but for simplicity only the V.24 circuit names are used.

Your Datacom Analyzer as DTE When your Datacom Analyzer is configured as

a DTE, it can be connected to a DCE (normally a modem or some other data set) making it possible to test the whole datacom circuit from end to end. The DCE under test always supplies data (on RD) and clock (on RC) to the Datacom Analyzer.

Datacom Analyzer Transmitter Supplies Clock to DCE Under Test

The Datacom Analyzer uses its internal synthesizer to clock out data (on TD) to the DCE under test. It supplies a clock on XTC which should be used to clock this data into the DCE.

The Datacom Analyzer does not use the clock on TC, if provided by the DCE under test.

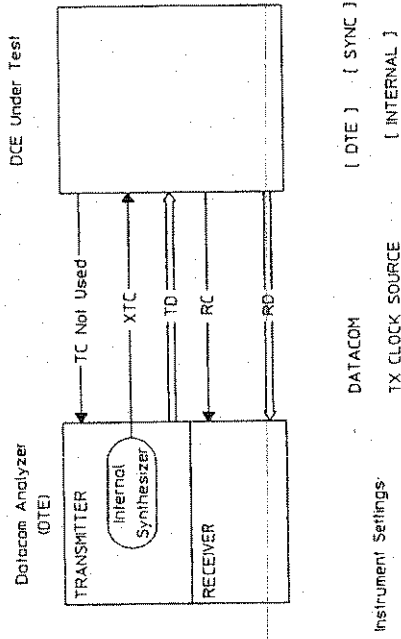

DCE Under Test Supplies Clock to Datacom Analyzer Transmitter

The Datacom Analyzer uses the clock supplied on TC to clock out data (on TD) to the DCE under test. A delayed version of this clock is sent back to the DCE on XTC.

With this configuration, there are two ways that the DCE can clock in data from the Datacom Analyzer:

- The data is clocked into the DCE coincident with the clock it is supplying on TC. XTC is not used by the DCE. This approach is appropriate at lower data rates.
- The delayed clock on XTC is used to clock data into the DCE. This approach is more appropriate at higher data rates.

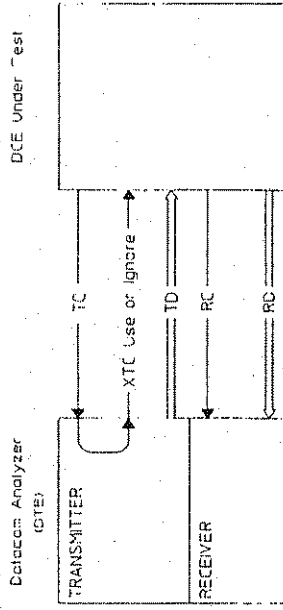

Instrument Settings DATACOM [DTE : [SYNC]
TX CLOCK SOURCE [INTERFACE]

Your Datacom Analyzer as DCE

When your Datacom Analyzer is configured as a DCE, it can be connected to terminal equipment for confidence checking. It can also be connected to transmission equipment which has been configured DTE.

Like a real data test set, the Datacom Analyzer Transmitter supplies data (on RD) and clocks (on RC and TC) to the DTE under test. Both clock signals are derived from the same source.

DTE Under Test Supplies Clock to Datacom Analyzer Receiver

The Datacom Analyzer uses the clock supplied on XTC to clock in data (on TD). The DTE under test may have generated this clock internally or may have derived it from the clock supplied by the Datacom Analyzer (on TC).

The Datacom Analyzer uses its internal synthesizer to clock out data (on RD) and also to derive clock signals (on RC and TC).

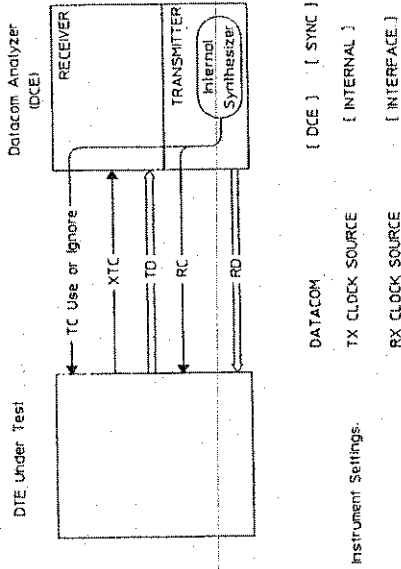

Datacom Analyzer Transmitter Supplies Clock to Datacom Analyzer Receiver

The Datacom Analyzer clocks in data (on TD) using the same clock that it supplies to the DTE under test (on TC). It follows that the DTE *must* use TC to clock out data on TD. The Datacom Analyzer does not use the clock on XTC, if provided by the DTE under test.

The Datacom Analyzer uses its internal synthesizer to clock out data (on RD) and also to derive clock signals (on RC and TC).

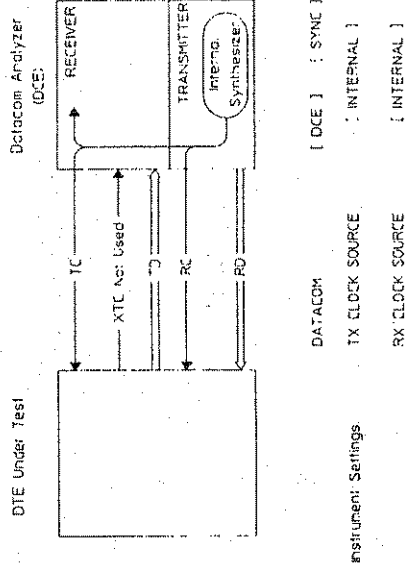

DATAKOM [DCE] [SYNC]
 instrument: Settings [DCE] [INTERNAL]
 TX CLOCK SOURCE [INTERNAL]
 RX CLOCK SOURCE [INTERNAL]

DTE Under Test Supplies Clock to Datacom Analyzer Receiver and Transmitter

The Datacom Analyzer uses the clock supplied on XTC to clock in data (on TD). The DTE under test should have generated this clock internally.

The Datacom Analyzer uses the clock supplied on XTC to clock out data (on RD) and also to derive clock signals (on RC and TC).

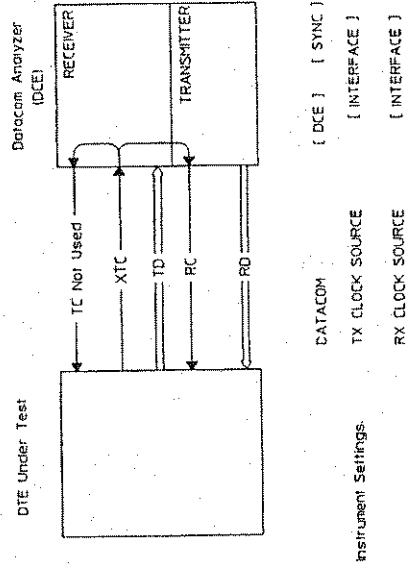

Bit Error Results

Bit Errors	The number of bit errors counted over the elapsed test period.
Bit Error Ratio (BER)	The ratio of bit errors counted to bits received over the elapsed test period.
Block Count	The number of blocks counted over the elapsed test period. Block length is selectable as 1E3 bits or auto. Auto defaults to the current PRBS length or 1E3 bits for non-BRBS pattern.
Block Errors	The number of block errors counted over the elapsed test period. Block error is defined as a block in which one or more bit errors occur.
Block Error Ratio (BLER)	The ratio of block errors counted to blocks received over the elapsed test period.

Error Seconds (ES) The number of asynchronous error seconds counted over the elapsed test period.
Asynchronous error second is defined as a second during which one or more bit errors occur.
Error seconds are not valid for Bit test periods.

Error-Free Seconds (EFS) The number of error-free seconds during the elapsed test period.

% Error-Free Seconds (%EFS) The number of error-free seconds expressed as a percentage of the elapsed test period.

Clock Slips The number of clock slips counted over the elapsed test period.

G.821 Analysis

G.821 Analysis, based on *available* and *unavailable* time, is only performed on synchronous data during a continuous or timed measurement.

A system becomes *available* when the error ratio measured in 1 second intervals is lower than the severely errored second threshold for ten or more consecutive seconds.

A system becomes *unavailable* when the error ratio measured in 1 second intervals is greater than the severely errored second threshold for ten or more consecutive seconds.

For the purpose of determining availability, *pattern sync loss* and *data loss* seconds are considered as seconds with error ratios exceeding the availability threshold. Power loss seconds are discarded.

Severely Errored Seconds (SES) The number of severely errored seconds counted over the total available time.
Severely errored second is a second during which there is an error ratio greater than the threshold value $1E-3$ (10^{-3}).

%Severely Errored Seconds (SES) The number of severely errored seconds counted over the total available time expressed as a percentage.

Error Seconds (ES) The number of errored seconds over the total available time.

% Error Seconds The number of errored seconds during available time expressed as a percentage.

Degraded Minutes The number of degraded minutes counted over the total available time.
 Degraded minute is a 60 second (1 minute) composite interval (excluding severely errored seconds) during which the error ratio is greater than the threshold value of $1E-6$ (10^{-6}).

% Degraded Minutes The number of degraded minutes during available time expressed as a percentage of the total minutes made up of available non-severely errored seconds.

% Availability The number or available seconds expressed as a percentage of the total elapsed time.

Unavailable Seconds The number of unavailable seconds counted over the total elapsed time.

Alarms

- Data Loss** The loss of valid data for a second or more. In sync mode it means *no clocks received*. In async mode it means *no characters received*.
- Data Loss Seconds** The number of seconds during which data loss was detected, counted over the elapsed test period.
- Power Loss** A power loss alarm occurs when the instrument power is interrupted during a BER measurement.
- Power Loss Seconds** The number of seconds for which the instrument's power supply is interrupted during a test period.
- Clock Slips** These occur when one or more bits have been added to or deleted from a received PRBS pattern.
- Clock Slip Seconds** The number of seconds during which clock slips were detected, counted over the elapsed test period.

Pattern Sync Loss Occurs if the error ratio exceeds a selectable threshold:

- Low - Error ratio ≥ 0.1 in ≥ 1000 bits
- Medium - Error ratio ≥ 0.25 in ≥ 1000 bits
- High - Error ratio ≥ 0.25 in $\geq 100,000$ bits

Sync loss can also be caused by a data loss alarm, by pressing **MANUAL RESYNC** or by changing pattern.

Pattern Sync Loss Seconds The number of seconds during which pattern sync loss was detected, counted over the elapsed test period.

Index

- 4
 - Asynchronous Data Rate, 2-10
 - ADR, 9-33
 - Asynchronous Operation, 2-10, 6-18, 6-19
 - 8
 - Asynchronous Parity
 - PAR, 9-30
 - Asynchronous Stop Bits
 - SBT, 9-31
 - ATH
 - Sync Loss AUTO Resync Threshold, 9-38
 - A
 - Audio Source
 - AUS, 9-40
 - AUS
 - Audio Source, 9-40
 - Accessories Available, 6-4
 - Accessories Supplied, 6-4
 - ACCESSORY Connector, 1-2
 - Accessory Identification Query
 - ACCID?, 9-27
 - ACCESSORY Port, 7-7
 - Accessory Revision Date Query
 - ACCREV?, 9-27
 - ACCID?
 - Accessory Identification Query, 9-27
 - ACCREV?
 - Accessory Revision Date Query, 9-27
 - ADR
 - Asynchronous Data Rate, 9-33
 - Alarm register, 9-77
 - Alarms, 6-21
 - :Alarm Seconds Results Query
 - RAL?, 9-51
 - Asynchronous Character Length
 - DSL, 9-30
 - Asynchronous Data - making a measurement, 1-7
- B
 - :Basic Results Query
 - RLR?, 9-50
 - Battery - Option B12, 7-3
 - Baud Rate
 - Instrument, 4-2
 - Printer, 4-2
 - BER Measurements, 6-23
 - :Bit Analysis Results Query
 - RAR?, 9-51
 - Bit Test Duration
 - DBG, 9-43
 - BLL
 - Block Length, 9-42
 - Block Length
 - BLL, 9-42

- C**
- Cable Connection - DCE to DTE, 4-3
- CCT?
 - Control Circuit Timing Line Status, 9-47
- Changing Battery Fuses, 7-5
- Changing the Batteries, 7-4
- Character Codes - for FOX Pattern, 2-18
- Character Format, 4-2
 - character length, 2-10
 - Parity, 2-10
 - Stop Bits, 2-10
- Character Format - Printer/Remote Control, 7-8
- CHARGING indicator (Option B12), 1-2
- Charging the Batteries (Option B12), 7-4
- CHL
 - Asynchronous Character Length, 9-30
- Clear
 - CLR, 9-22
- CLR
 - Clear, 9-22
- Commands, remote control, 9-21
- Computer, operation from, 9-5
- CON
 - Configuration, 9-22
- Configuration
 - CON, 9-22
- Control Circuit Status, 5-4
- Control Circuit Timing, 6-25
- Control Circuit Timing commands, 9-44
- Control Circuit Timing Compressed Data Query
 - RTZ?, 9-54
- Control Circuit Timing Data
 - RTD?, 9-53
- Control Circuit Timing DELAY A-B
 - TMM, 9-45
- Control Circuit Timing Delay Edge-A
 - TIS, 9-45
- Control Circuit Timing Delay Edge-A Sense
 - STE, 9-45
- Control Circuit Timing Delay Edge-B
 - TIE, 9-46
- Control Circuit Timing Delay Edge-B Sense
 - SPE, 9-46
- Control Circuit Timing Line Status
 - CCT?, 9-47
- Control Circuit Timing RANGE
 - TRG, 9-44
- Control Circuit Timing - RTS/CTS
 - delay measurement, 1-17
- Control Circuit Timing Status
 - TTA?, 9-47
- Control Circuit Timing Trace Enable
 - TTR, 9-46
- Control Circuit Timing Trigger
 - TDP, 9-44
- Control DCE CTS/CS/I Circuits
 - DCC1, 9-48
- Control DCE DCD/RR/RLSD Circuits
 - DCC3, 9-48
- Control DCE DSR/DM Circuits
 - DCC2, 9-48
- Control DTE DTR/TR Circuits
 - DTC2, 9-49
- Control DTE RTS/RS/C Circuits
 - DTC1, 9-49
- CSE
 - Receive Clock Source Sense, 9-32
- D**
- Data Bits, 4-2
- Data Character Length, 2-10
- Datacom Analyzer Configuration, 1-3, 2-2
- Datacom Connector, 1-2

)
)
)

DATACOM indicator, 1-3
 Databcom Interface
 RS-232, 5-2
 RS-449, 5-2
 V.11, 2-4
 V.24, 2-4
 V.35, 2-4
 X.21, 2-4
 DAtacom Interface
 V.35, 5-2
 Databcom Interface Type
 DIF, 9-29
 Databcom Module Connection -
 ACCESSORY Port, 7-7
 Data Logging, 6-30
 Data Rate - Async, 2-10
 Date Flow - FOX Pattern, 2-18
 DBG
 Bit Test Duration, 9-43
 DCC1
 Control DCE CTS/CS/I Circuits,
 9-48
 DCC2
 Control DCE DSR/DM Circuits, 9-48
 DCC3
 Control DCE DCD/RR/RLSD
 Circuits, 9-48
 DCE Circuits, 2-9
 Data and Clock (TD, RD, XTC, TC
 and RC), 2-9
 Inputs (RTS and DTR), 2-9
 Outputs (CTS, DSR and DCD), 2-9
 DCE Emulation, 2-7, 5-3, 6-16
 DCE to DTE Cable Connection, 4-3
 Default conditions, 9-79
 Default Settings, 1-4
 DEL?
 Delay Measurement Query, 9-52
 Delay between Two Events, 5-8
 Delay Measurement Query
 DEL?, 9-52

Delay - RTS/CTS, 5-6
 DEM
 Emulation Type, 9-29
 DIF
 Databcom Interface Type, 9-29
 DIP
 Receive Data Polarity, 9-37
 Display Current Results as Graphs, 3-8
 Display EFS or %EFS result, EFS, 9-36
 Displaying
 Alarms, 3-3
 Analysis Results, 3-3
 Bit Error Results Results, 3-2
 Graphs, 3-5
 TX/RX Frequency, 3-4
 Displaying Graphs of all Errors and
 Alarms, 3-6
 Displaying Graphs of part of a
 Measurement, 3-7
 DOP
 Transmit Data Polarity, 9-37
 DPD
 Test Period Type, 9-42
 DPT
 Pattern Type, 9-35
 DSL
 Receiver Sync Gain Control, 9-38
 DTC1
 Control DTE RTS/RS/C Circuits,
 9-49
 DTC2
 Control DTE DTR/TR Circuits, 9-49
 DTD
 Single Test Period Duration, 9-43
 DTE Circuits
 Data and Clock (TD, RD, XTC, TC
 and RC), 2-8
 Inputs (CTS, DSR and DCD), 2-8
 Outputs (RTS and DTR), 2-8
 DTE Emulation, 2-7, 5-3, 6-15
 DTI

Timing Type, 9-29
DTR, 4-2

E
EFS, display EFS or %EFS result, 9-36
EFS or %EFS selection, 1-6
Elapsed Bit Result Query
 ELB?, 9-52
Elapsed Time, 6-30
ELB?
Elapsed Bit Result Query, 9-52
Emulating
 DCE, 2-7, 5-3
 DTE, 2-7, 5-3
Emulation Type
 DEM, 9-29
ENQ/ACK, 4-2
ERR?
 Error Code Query, 9-26
 Error Add, 6-18
 Error addition commands, 9-41
 Error Code Query
 ERR?, 9-26
 Error Codes, 9-68
 Errors Insertion, 2-21
 ERR? responses, 9-68
 %ESF or ESF display selection, 2-7
 ESF or %ESF display selection, 2-7

F
Fixed Patterns, 2-17
FOX Character Code
 FXC, 9-39
FOX Character Codes, 2-18
FOX Flow Control
 FXF, 9-39
FOX Pattern - async TX only, 2-18
Frequency, 6-24
Frequency Results Query
 FRQ?, 9-52
 FRQ?

Frequency Results Query, 9-52
Fuses, 7-2
FXC
 FOX Character Code, 9-39
FXF
 FOX Flow Control, 9-39

G
Graphs, 3-5, 6-27
Graphs of all Errors and Alarms, 3-6
Graphs of part of a Measurement, 3-7

H
HP-IB address, 9-15
HP-IB connector, 9-12

I
ICS
 Transmit Clock Source Sense, 9-31
ID
 Instrument Identification, 9-25
 Initial Inspection, 7-1
 Inserting Errors into TX Data, 2-21
 Instrument Baud Rate, 4-2
 Instrument Identification
 ID, 9-25
 Instruments Covered by Manual, 6-2
 Instrument Settings Commands, 9-29
 Instrument Settings - Recalled from Store, 2-3
 Isolating Switches, 1-5, 2-4

K
KEY?
 Key Query, 9-23
 Keyboard Function Commands, 9-67
 Key Query
 KEY?, 9-23

RDY?, 9-26
 Ready register, 9-76
 Real Time Clock, 6-29
 Recalling stored instrument settings, 2-3
 Receive Clock Source
 RXC, 9-32
 Receive Clock Source Sense
 CSE, 9-32
 Receive Data Polarity
 DIP, 9-37
 Receiver Sync Gain Control
 DSL, 9-38
 REMLOG, Print Now, 9-68
 Remote
 RMT, 9-21
 Remote Control - Character Format, 7-8
 Remote control commands, 9-21
 Remote control common capability messages, 9-21
 Remote control, direct connection, 9-3
 Remote Control Port, 7-7
 Remote control, preparation, 9-1
 Remote control status registers, 9-71
 Remote operation command example, 9-6
 Remote operation, general information, 9-6
 Repeat Sweep, 5-6, 5-8
 Request Service Mask
 RQS, 9-23
 Reset
 RST, 9-21
 Result Query Commands, 9-50
 Results Storage, 2-23
 REV?
 Revision Date Query, 9-25
 Revision Date Query
 REV?, 9-25
 RLLR?
 Basic Results Query, 9-50
 RMT
 Remote, 9-21
 RQS
 Request Service Mask, 9-23
 RS-232 Interface, 5-2
 RS-232 Port (on side panel), 7-7
 RS-449 Interface, 5-2
 RST
 Reset, 9-21
 RTD?
 Control Circuit Timing Data, 9-53
 RTS/CTS Delay, 5-6
 RTZ?
 Control Circuit Timing-Compressed
 Data Query, 9-54
 Running a measurement, 2-25
 RXC
 Receive Clock Source, 9-32
 RX Clock Source, 2-15
 RX Data Polarity, 2-19
 S
 SADR?
 Stored Asynchronous Data Rate, 9-61
 Safety Considerations, 6-2
 Sampling Resolution, 2-23
 SATH?
 Stored Sync Loss AUTO Resync
 Threshold, 9-64
 SBLL?
 Stored Block Length, 9-63
 SBT
 Asynchronous Stop Bits, 9-31
 SCHL?
 Stored Asynchronous Character
 Length, 9-59
 SDEM?
 Stored Emulation Type, 9-59
 SDIF?
 Stored Interface Type, 9-58

- L**
- LCL
 - Local, 9-21
 - Line Fuses, 7-2
 - Local
 - LCL, 9-21
 - Logging Results, 6-30
- LOW BATTERY** indicator (Option B12, 1-2)
- M**
- MAN
 - Manual Resync, 9-67
- Manual Resync
 - MAN, 9-67
- Mating Connectors, 7-6
- Measurements, 6-23
- MODE**
 - Telecom/Datacom Mode, 9-67
 - Modem connection, 9-2
- O**
- OCS**
 - Transmit Output Clock Sense, 9-37
- Operating Environment, 7-11
- OPT?**
 - Options Query, 9-27
- Option B12 - Battery, 7-3
- Options Available, 6-3
- Options Query
 - OPT?, 9-27
- Other-Page datacom settings, 9-37
- P**
- Pacing - XON/XOFF, ENQ/ACK** or DTR, 4-2
- PAR**
 - Asynchronous Parity, 9-30
 - Parity, 2-10, 4-2
 - Patch Points, 1-5, 2-4
 - Pattern Polarity
- POL**, 9-36
 - Patterns, 2-17, 6-22
 - Pattern Sync Threshold, 2-22
 - Pattern Type
 - DPT, 9-35
- Pattern Polarity, 9-36
- Polarity - Rx & TX Data, 2-19
- Power Cable, 7-3
- Power Connection, 1-2
- Power Requirements, 7-2
- Power Source, 6-31
- PRBS Patterns, 2-17
- Preparation for Use, 7-2
- Print Current Results, 4-8
- Print Current Results as Graphs, 4-8
- Printer Baud Rate, 4-2
- Printer Output - Character Format, 7-8
- Printer Port, 7-7
- Printers, 4-2
- Printing Graphs, 4-10
- Printing Setup
 - Using an Alternative (non Hewlett-Packard) Printer, 4-6
 - Using Hewlett-Packard Printer, 4-3
- Printing Stored Results, 4-9
- Print Now, REMLOG, 9-68
- Print Settings, 4-8
- Programming tips, 9-19
- Protocol - XON/XOF, ENQ/ACK or DTR, 4-2
- Rack Mount Kits**, 7-10
- RAL?**
 - Alarm Seconds Results Query, 9-51
- RAR?**
 - Bit Analysis Results Query, 9-51
- RDY?**
 - Ready Code Query, 9-26
 - Ready Code Query

SDIP? Stored Receive Data Polarity, 9-63
 SDOP? Stored Alarm Seconds Results Query, 9-65
 SDPT? Stored Transmit Data Polarity, 9-62
 SDR Stored Pattern Type, 9-62
 SDSL? Synchronous Data Rate, 9-34
 Stored Receiver Sync Gain Control, 9-63
 SDTI? Stored Timing Type, 9-59
 SELB? Stored Sync Loss AUTO Resync Threshold, 9-66
 Self-test
 TST, 9-27
 Self Test, 6-31
 SER Serial Number, 9-25
 Serial Number
 SER, 9-25
 Single Sweep, 5-6, 5-8
 Single Test Period Duration
 DTD, 9-43
 SMD? Stored Graphical Data Query, 9-56
 SMOD Stored Telecom/Datacom Mode, 9-58
 SMZ? Stored Graphical Data in Compressed Form Query, 9-57
 SPAR? Stored Asynchronous Parity, 9-60
 SPE Control Circuit Timing Delay Edge-B Sense, 9-46
 Specification, 6-1, 6-5
 SPOL? Stored Pattern Polarity, 9-62
 SRAL? Stored Alarm Seconds Results Query, 9-65
 SRAR? Stored Bit Analysis Results Query, 9-65
 SRLR? Stored Basic Results Query, 9-64
 SRXC? Stored Receive Clock Source, 9-60
 SSBT? Stored Asynchronous Stop Bits, 9-60
 SDDR? Stored Synchronous Data Rate, 9-61
 STA? Status/Events Query, 9-26
 Starting/Stopping a test, 2-25
 Status/Events Query
 STA?, 9-26
 Status Query
 STB?, 9-26
 Status register A, 9-71
 Status register B, 9-74
 Status registers, 9-71
 STB? Status Query, 9-26
 STE Control Circuit Timing Delay Edge-A Sense, 9-45
 Stop Bits, 2-10, 4-2
 Storage and Shipment, 7-11
 Storage - Results, 6-29
 Storage - Settings, 6-30
 Stored Alarm Seconds Results Query
 SRAL?, 9-65
 Stored Asynchronous Character Length
 SCHL?, 9-59
 Stored Asynchronous Data Rate
 SADR?, 9-61
 Stored Asynchronous Parity
 SPAR?, 9-60

Stored Asynchronous Stop Bits
 SSBT?, 9-60
 Stored Basic Results Query
 SRLR?, 9-64
 Stored Bit Analysis Results Query
 SRAR?, 9-65
 Stored Block Length
 SBLL?, 9-63
 Stored Elapsed Bits
 SELB?, 9-66
 Stored Emulation Type
 SDEM?, 9-59
 Stored Graphical Data in Compressed
 Form Query
 SMZ?, 9-57
 Stored Graphical Data Query
 SMD?, 9-56
 Stored Interface Type
 SDIF?, 9-58
 Stored Measurement and Graphics Query
 Commands, 9-56
 Stored Pattern Polarity
 SPOL?, 9-62
 Stored Pattern Type
 SDPT?, 9-62
 SUPP?, 9-62
 Stored Receive Clock Source
 SRXC?, 9-60
 Stored Receive Data Polarity
 SDIP?, 9-63
 Stored Receiver Sync Gain Control
 SDSL?, 9-63
 Stored Results as Graphs, 3-9
 Stored Results as Text, 3-10
 Stored Synchronous Data Rate
 SSDR?, 9-61
 Stored Sync Loss AUTO Resync
 Threshold
 SATH?, 9-64
 Stored Telecom/Datacom Mode
 SMOD, 9-58

Stored Timing Type
 SDTI?, 9-59
 Stored Transmit Clock Source
 STXC?, 9-60
 Stored Transmit Data Polarity
 SDOP?, 9-62
 Stored User Program Synchronous Data
 Rate
 SURR?, 9-61
 Storing Instrument Settings, 2-24
 Storing Results, 2-23
 STXC?
 Stored Transmit Clock Source, 9-60
 SUPP?
 Stored Pattern Type, 9-62
 SURR?
 Stored User Program Synchronous
 Data Rate, 9-61
 Sweep
 Repeat, 5-6, 5-8
 Single, 5-6, 5-8
 Synchronous Data - making a
 measurement, 1-12
 Synchronous Data Rate
 SDR, 9-34
 Synchronous Operation, 2-12, 6-17, 6-19
 Synchronous TX Clock Source, 2-12
 Synchronous TX Data Rate, 2-12
 Sync Loss AUTO Resync Threshold
 ATH, 9-38

T

TDP
 Control Circuit Timing Trigger, 9-44
 Telecom/Datacom Mode
 MODE, 9-67
 Telephone lines, connecting to via
 modems, 9-2
 Terminal, control from, 9-7
 Terminal Emulation (DTE/DCE), 6-15

Terminal, setting up for operation from, 9-4

Test Period, 2-19

Test Period and Result configuration commands, 9-42

Test Periods, 6-24

Test Period Type
DPD, 9-42

TEST SELECT indicators, 1-3

TIE
Control Circuit Timing Delay Edge-B, 9-46

Timing Type
DTI, 9-29

TIS
Control Circuit Timing Delay Edge-A, 9-45

TMM
Control Circuit Timing DELAY A-B, 9-45

Transmit Clock Source
TXC, 9-31

Transmit Clock Source Sense
ICS, 9-31

Transmit Data Polarity
DOP, 9-37

Transmit Output Clock Sense
OCS, 9-37

TRG
Control Circuit Timing RANGE, 9-44

TST
Self-test, 9-27

TTA?
Control Circuit Timing Status, 9-47

TTR
Control Circuit Timing Trace Enable, 9-46

TXC
Transmit Clock Source, 9-31

TX Clock Source, 2-12, 2-13

TX Clock Source Trigger, 2-14

TX Data Polarity, 2-19

TX Data Rate, 2-12

U

UPP
User Defined Word Pattern, 9-36

URR
User Program Synchronous Data Rate, 9-35

User Defined Word Pattern
UPP, 9-36

User Program Synchronous Data Rate
URR, 9-35

V

V.11 Interface, 2-4, 2-6, 6-8

V.11/V.35/X.21 Leased Indicators, 6-14

V.24 Breakout, 6-13

V.24 indicators, 1-5

V.24 Interface, 2-4, 6-6

V.35 Interface, 2-4, 2-6, 5-2, 6-11

Viewing
Alarms, 3-3

Analysis Results, 3-3

Bit Error Results, 3-2

Graphs, 3-5

TX/RX Frequency, 3-4

Viewing Current Results as Graphs, 3-8

Viewing Graphs of all Errors and Alarms, 3-6

Viewing Graphs of part off a Measurement, 3-7

X

X.21 Interface, 2-4

XON/XOFF, 4-2

Z

Zoom, 3-7

** For HP INTERNAL REFERENCE ONLY *

Manufacturing Part Number

15901-90014



Reorder Number
15901-90014

Product of U.K.